

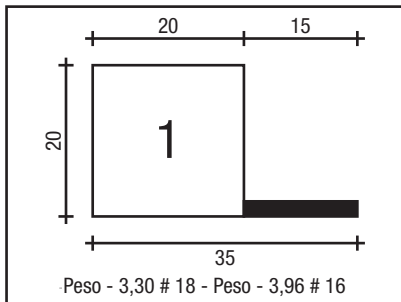

CATÁLOGO DE PRODUTOS



CADEIRINHA 20 X 20



CADEIRINHA 20 X 25

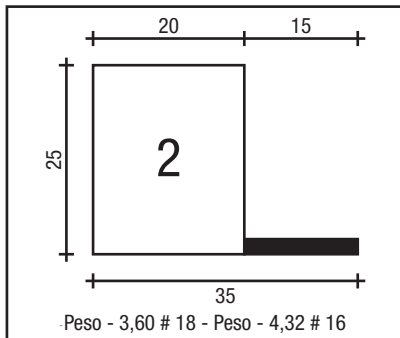

CADEIRINHA 25 X 25

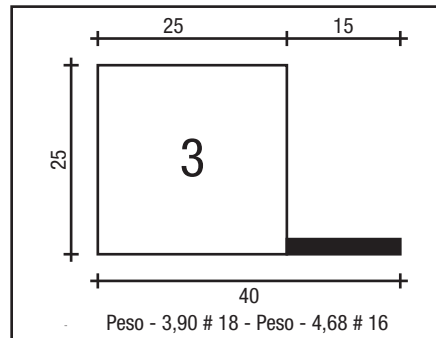

CADEIRINHA 30 X 25

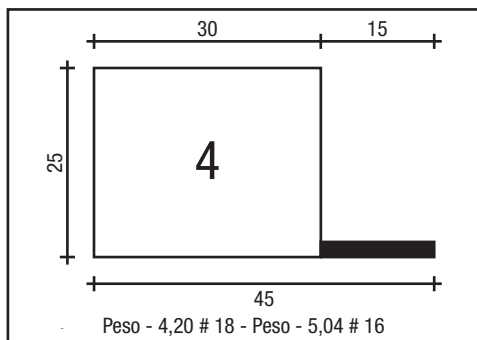

CADEIRINHA 40 X 25

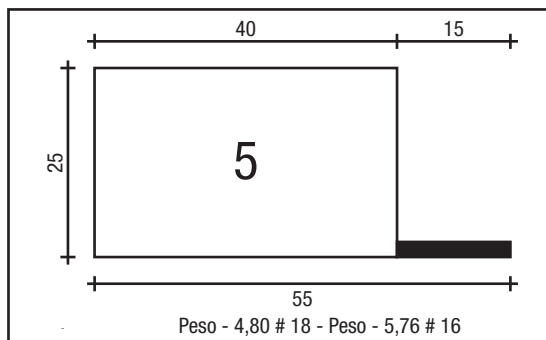

CADEIRINHA 50 X 25

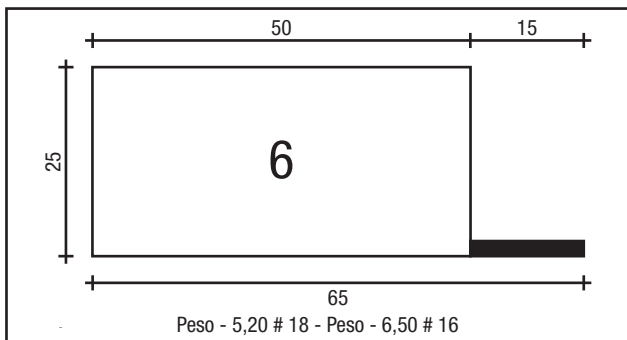

CADEIRINHA 65 X 25

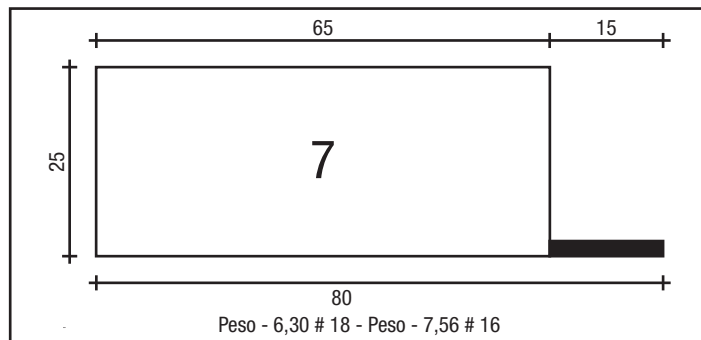

CADEIRINHA 80 X 25

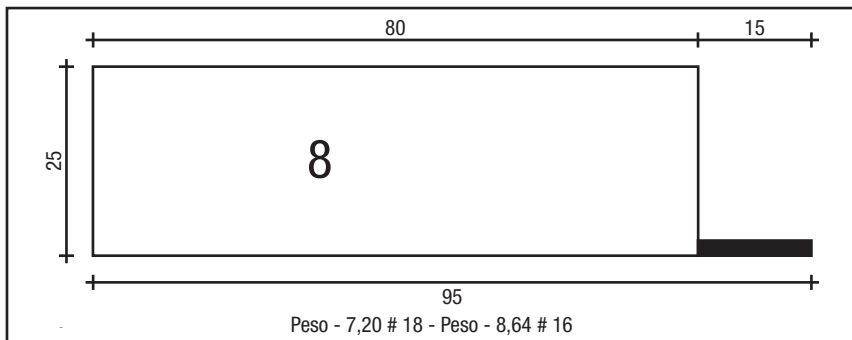

CADEIRINHA 100 X 25

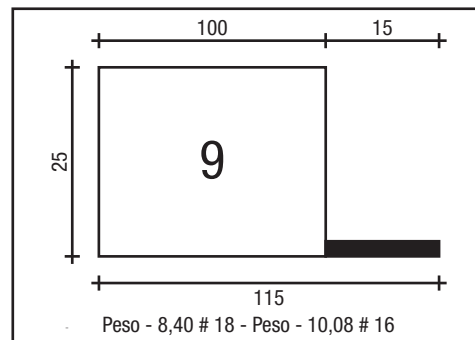

ALMOFADA 150 X 25

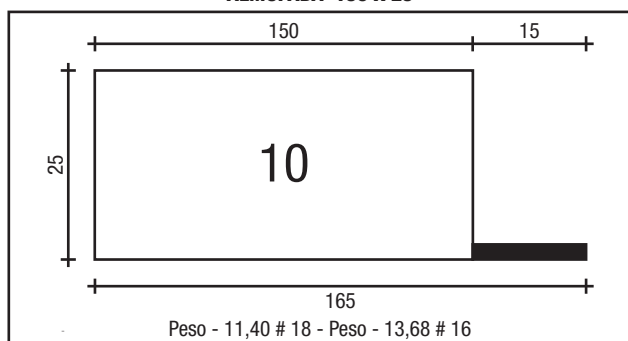

ALMOFADA 200 X 25

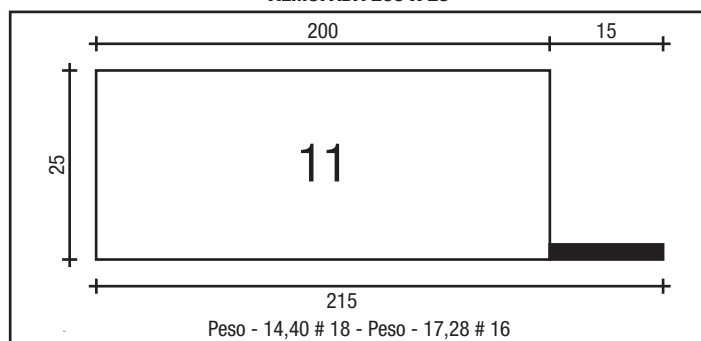

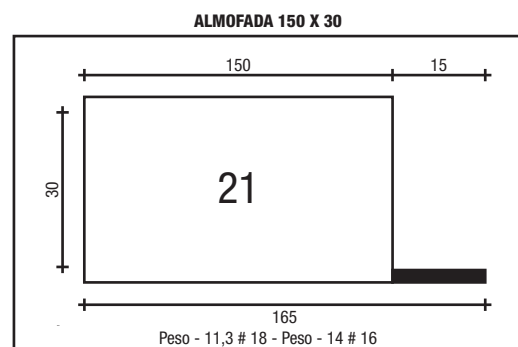
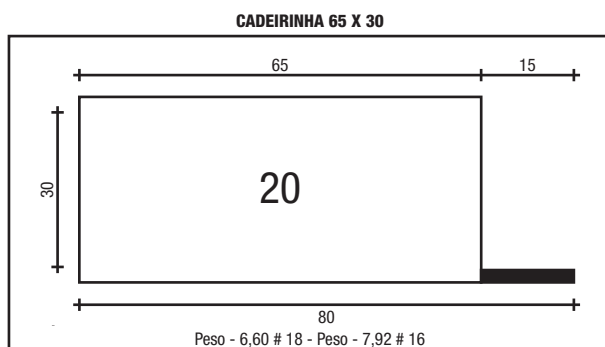
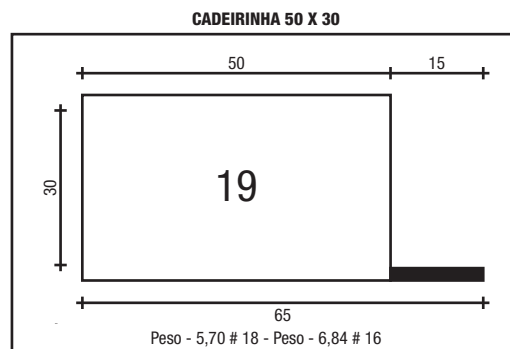
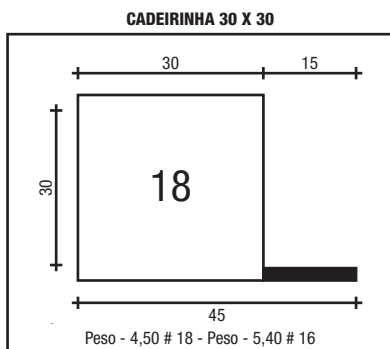
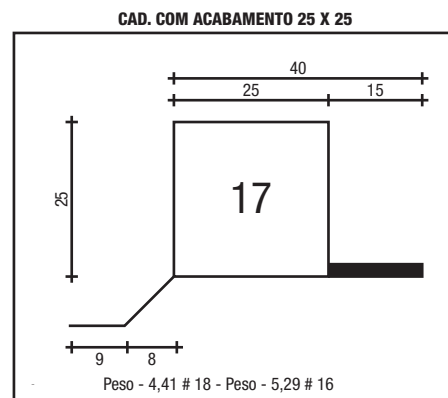
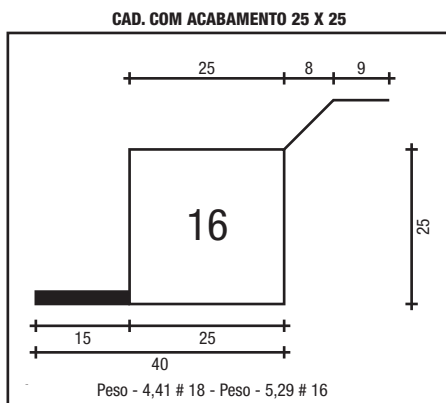
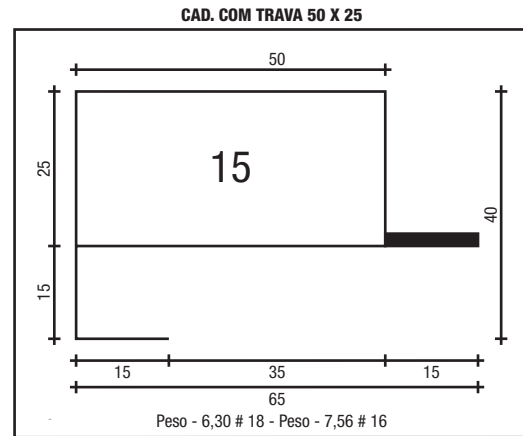
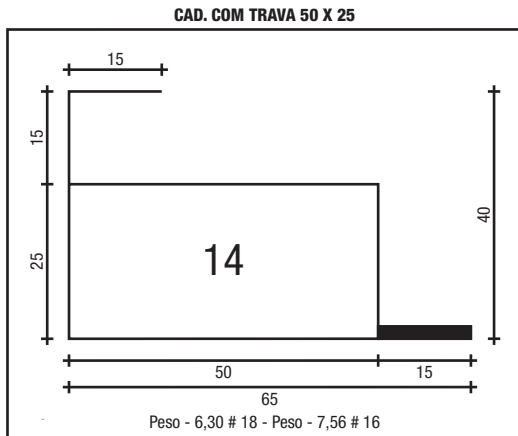
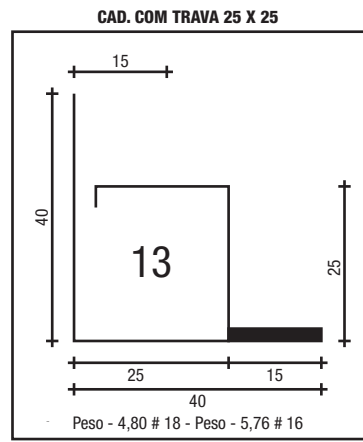
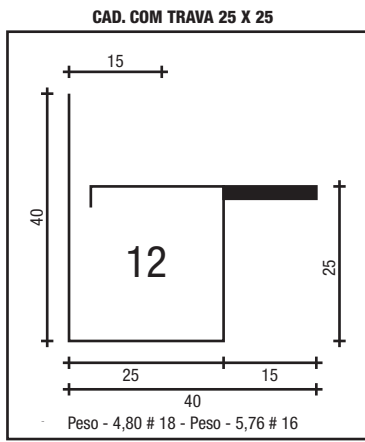

ALMOFADA 200 X 30

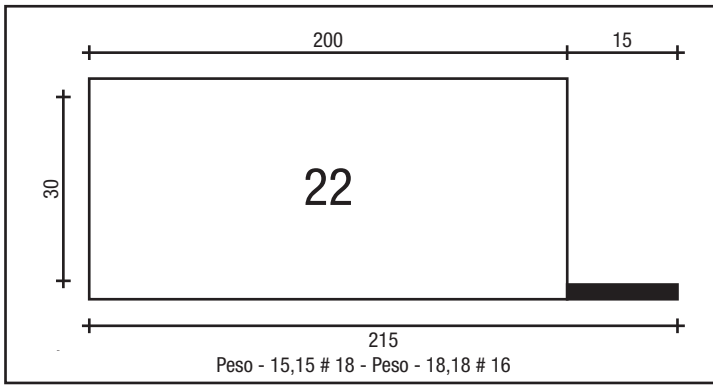

CAD. COM TRAVA 30 X 30

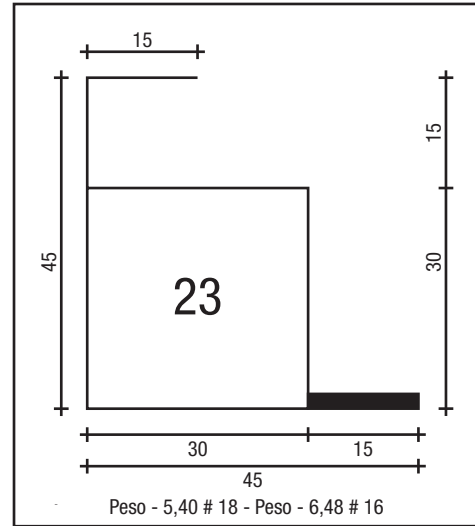

CAD. COM TRAVA 30 X 30

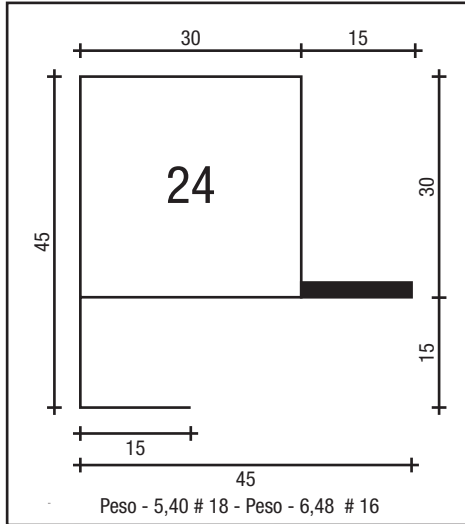

CAD. COM GRADE 30 X 40

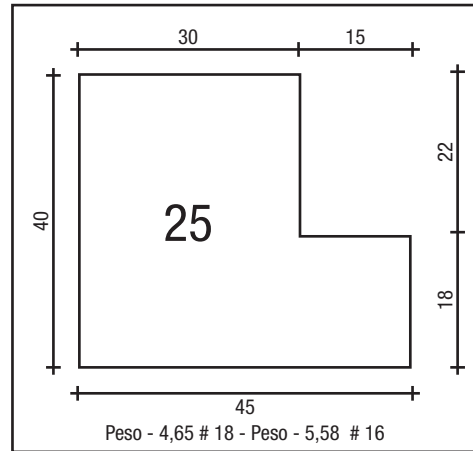

CAD. COM GRADE 50 X 40

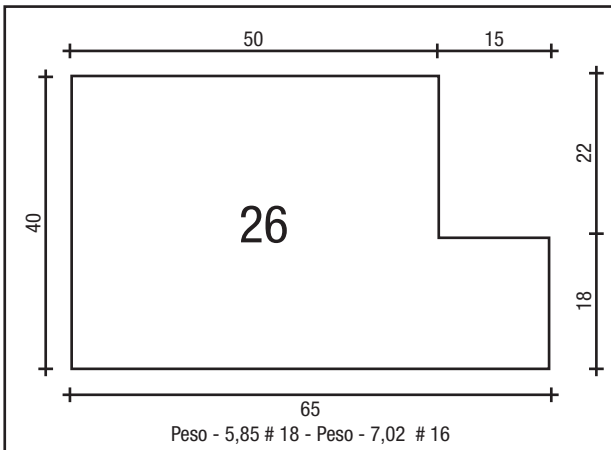

CAD. COM GRADE 80 X 40

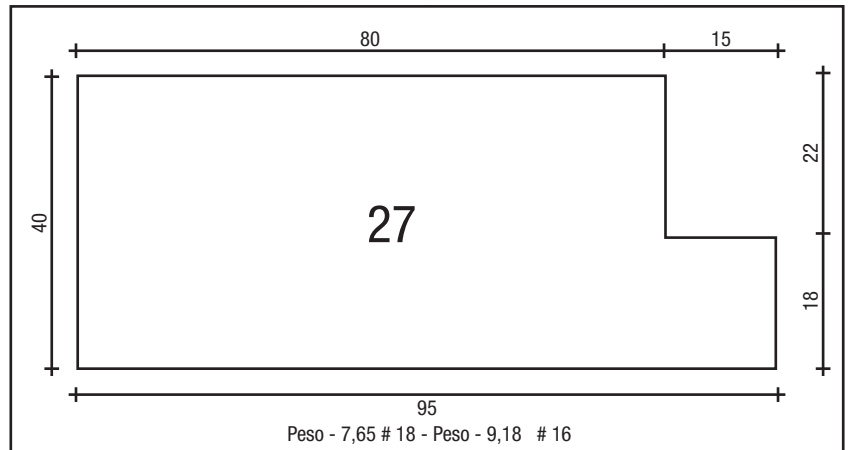

ALMOFADA COM GRADE 150 X 40

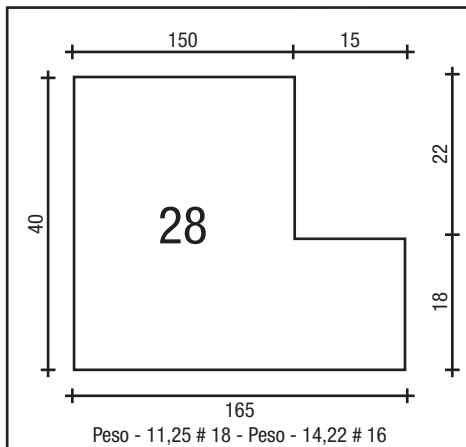

ALMOFADA COM GRADE 200 X 40

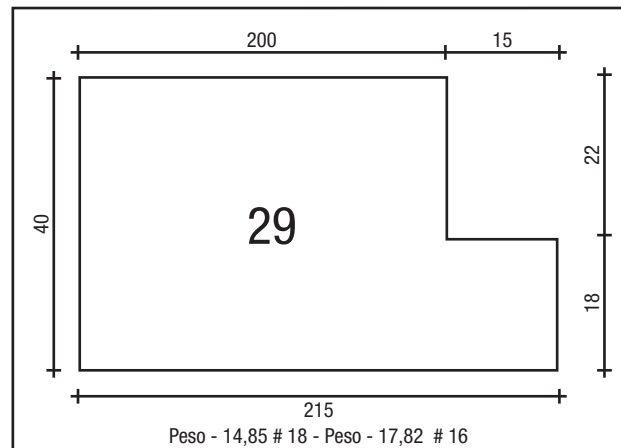

CAD. ABERTA 25 X 25

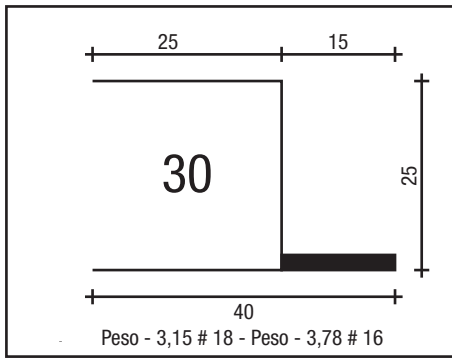

CAD. MAX BICO 15

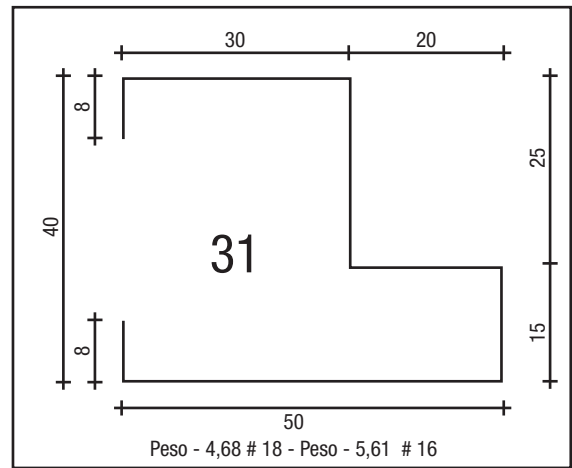

CAD. MAX BICO 18

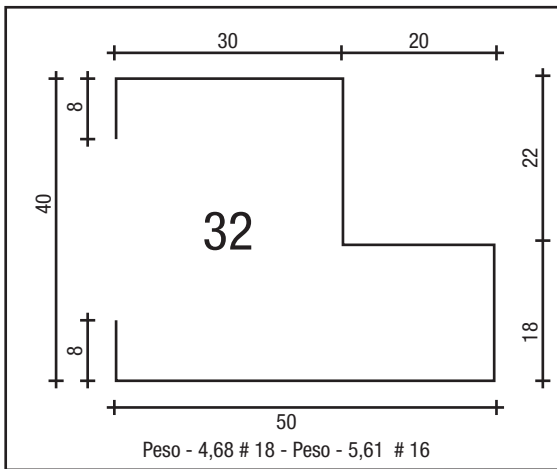

CAD. MAX ABERTA BICO 20

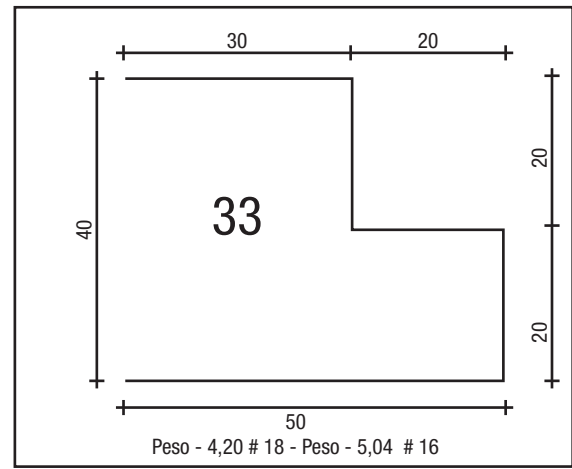

TEE 25 X 25

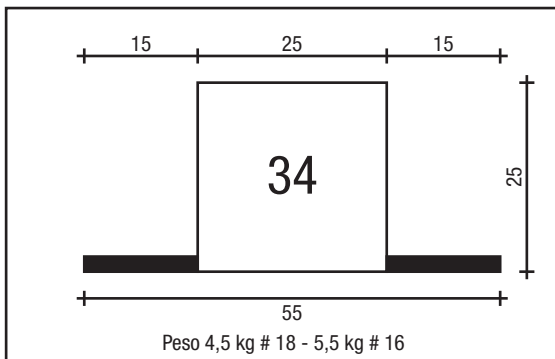

TEE 30 X 25

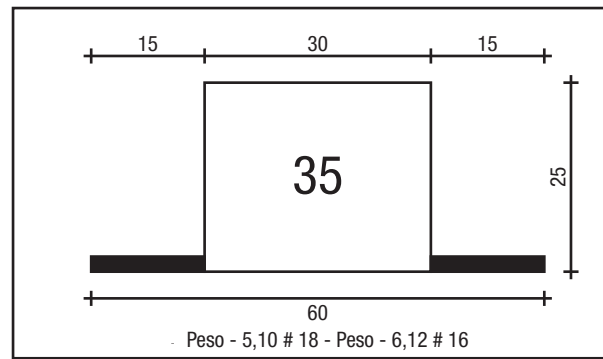

TEE 30 X 30

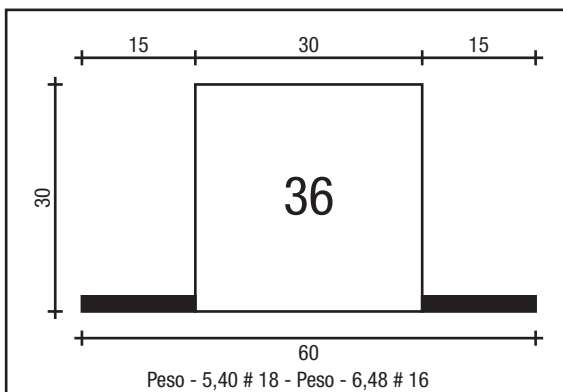

TEE MAX BICO 15

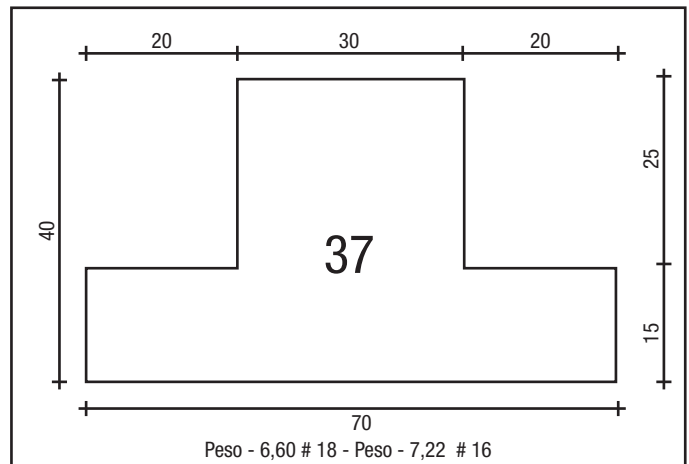

TEE MAX BICO 18

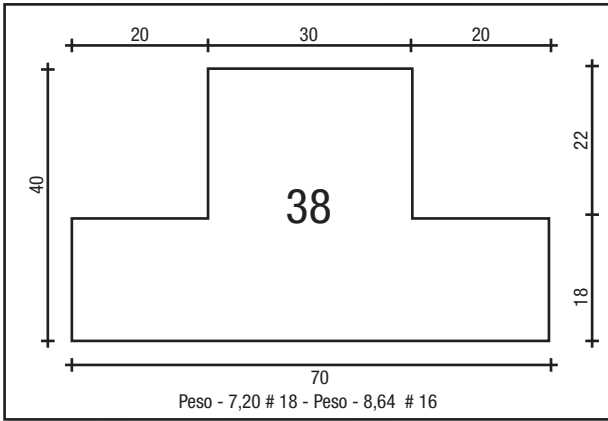

TEE MAX BICO 20

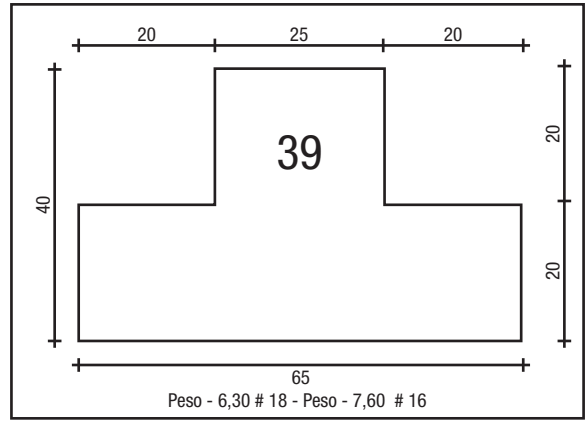

BATENTE 45

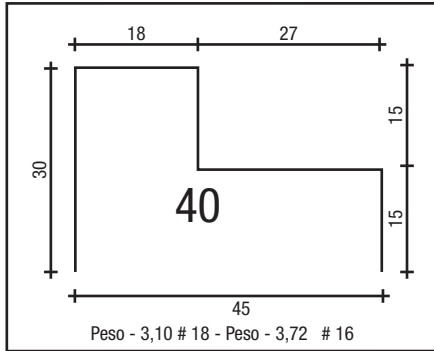

BATENTE 50

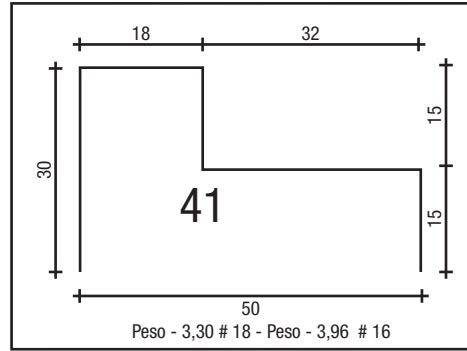

BATENTE 60

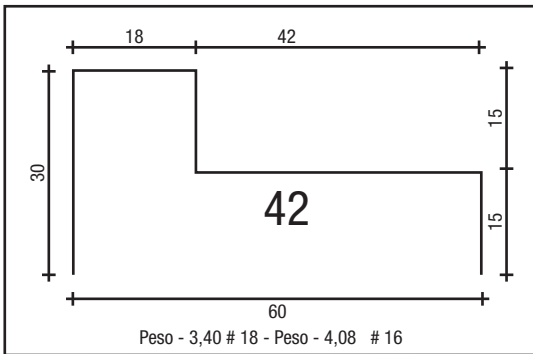

BATENTE 77

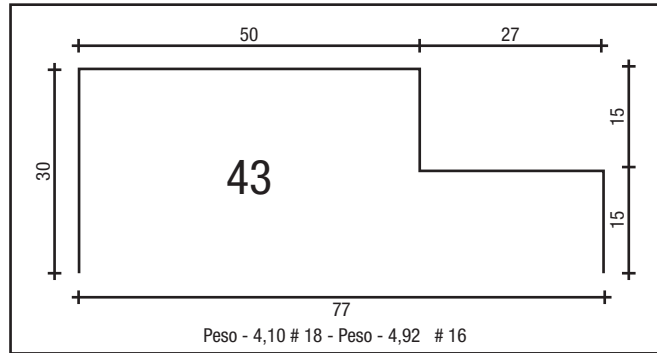

BATENTE 122

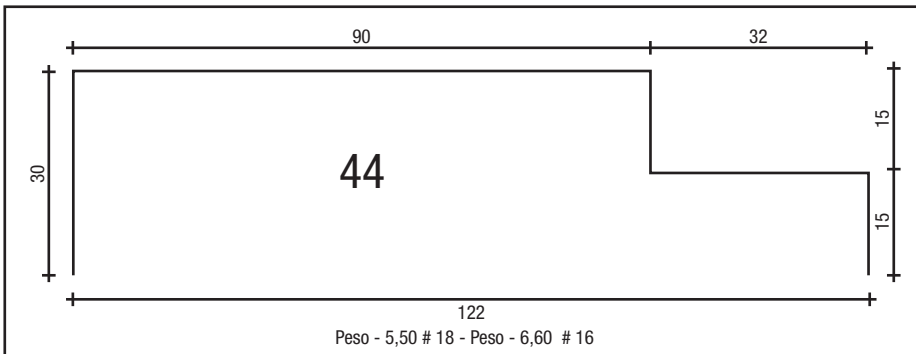

BATENTE RETO 45

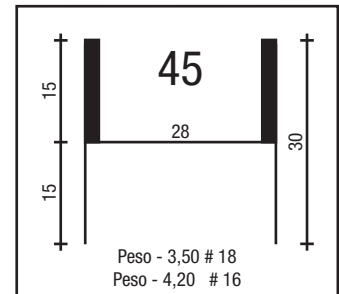

BATENTE RETO 82

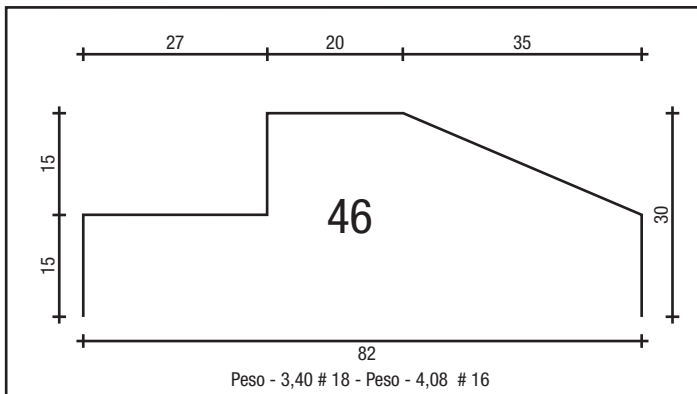

BATENTE RETO 47

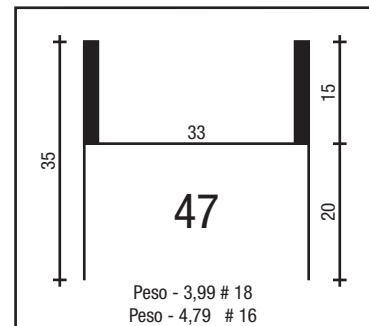

BATENTE VENEZIANA

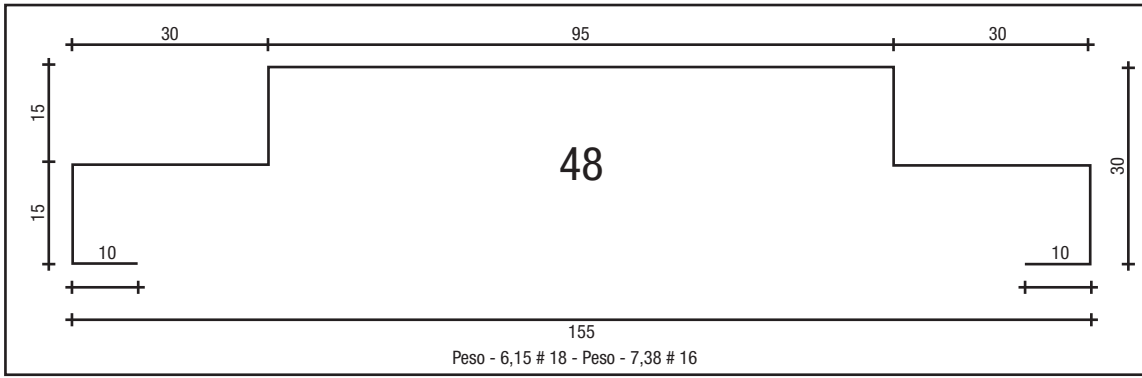

BATENTE 130

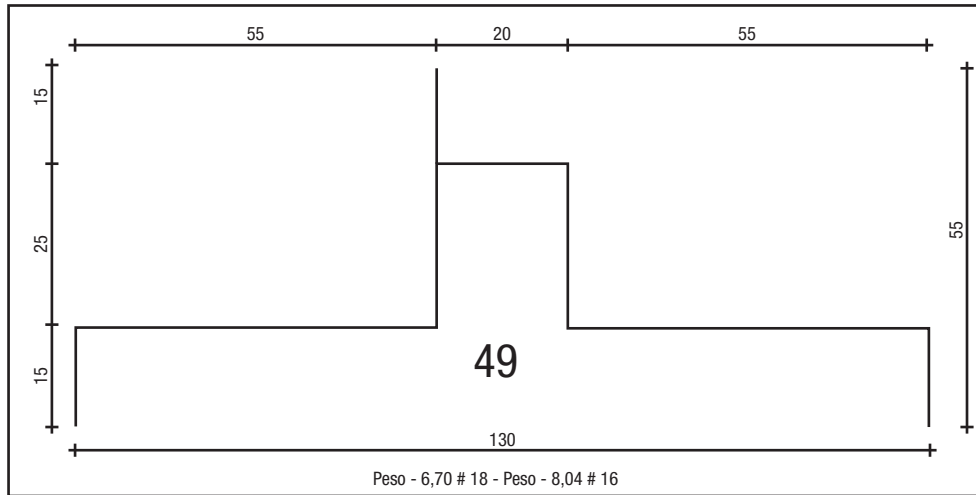

BATENTE 75

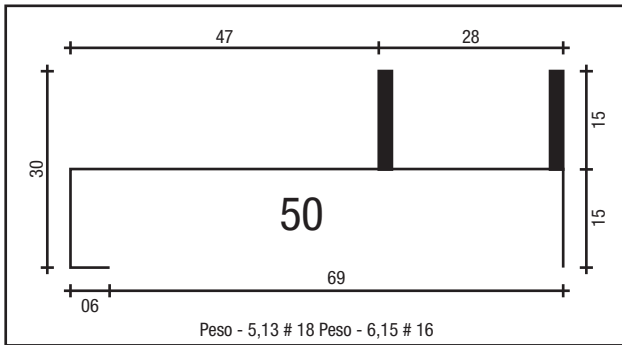

Z MAX 25 X 15 X 20 X 13

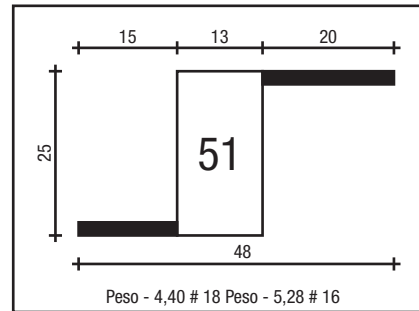

Z MAX 28 X 15 X 20 X 13

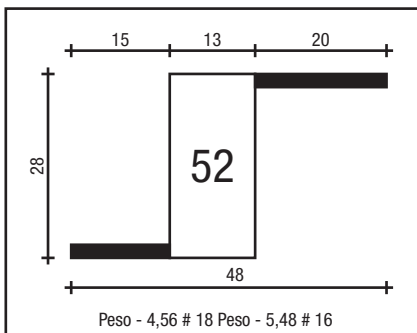

Z MAX 25 X 20 X 20 X 13

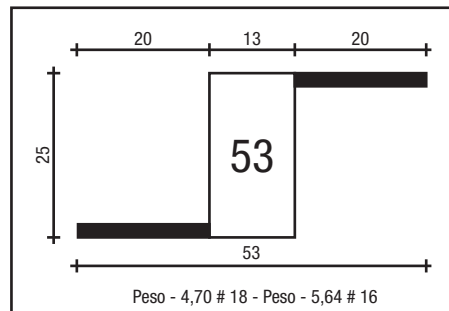

Z MAX 28 X 20 X 20 X 13

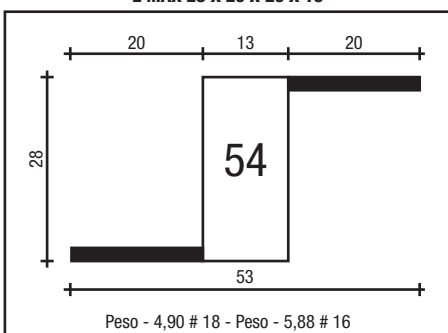

Z SIMPLES 20 X 20 X 20

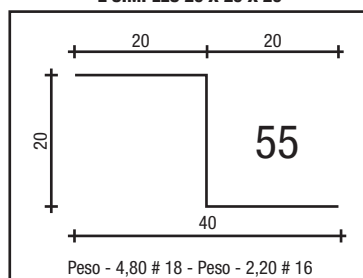

Z SIMPLES 20 X 22 X 15

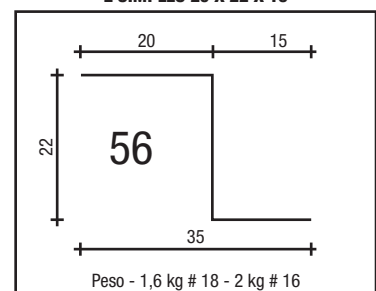

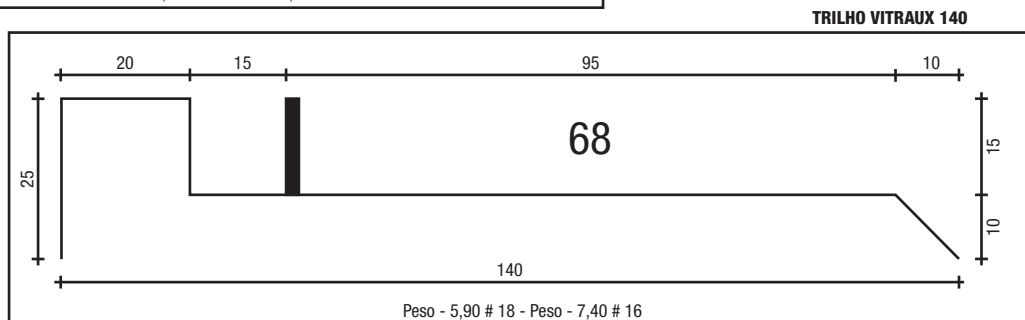
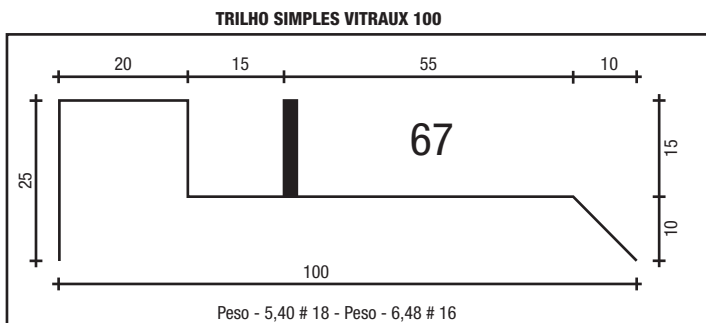
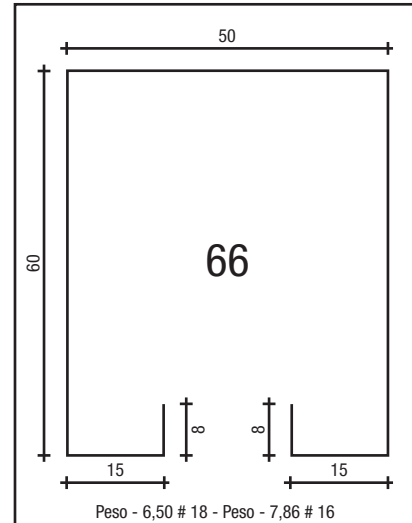
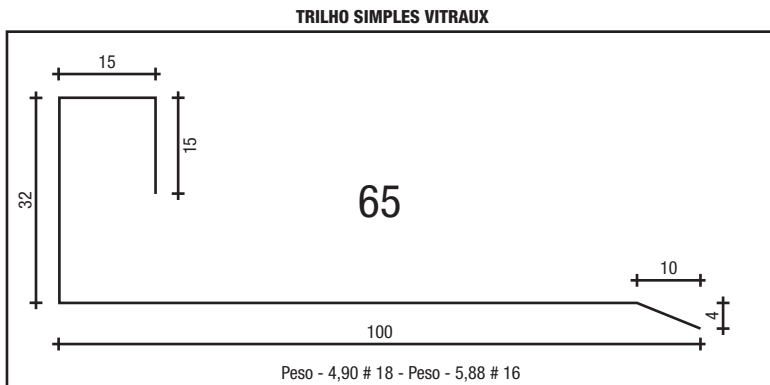
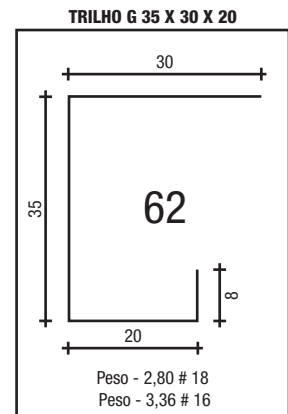
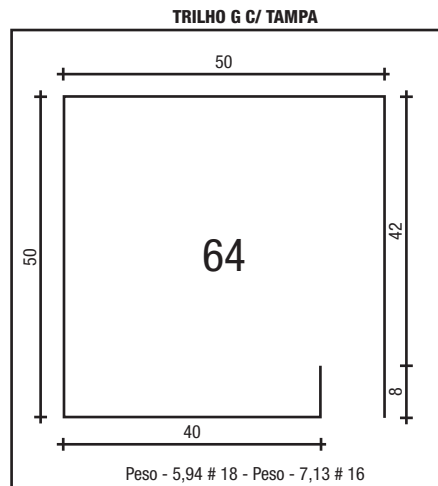
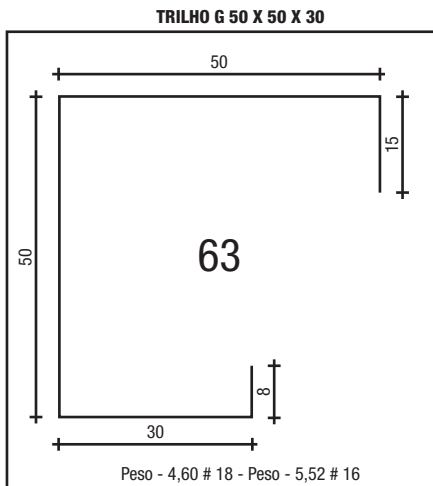
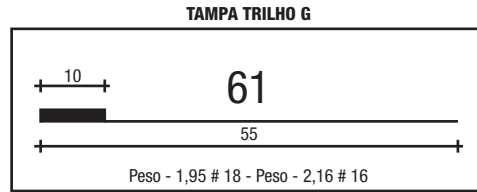
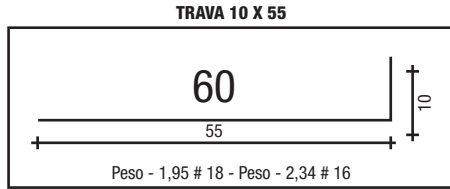
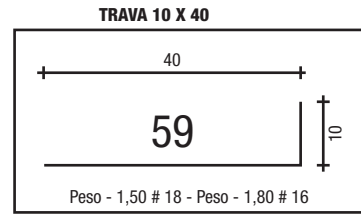
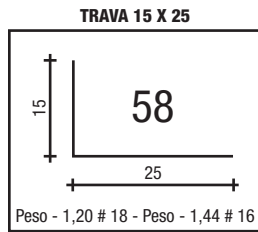
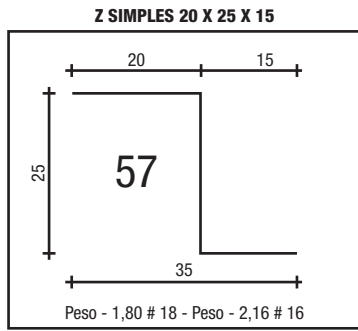

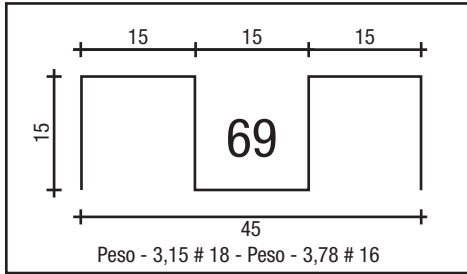
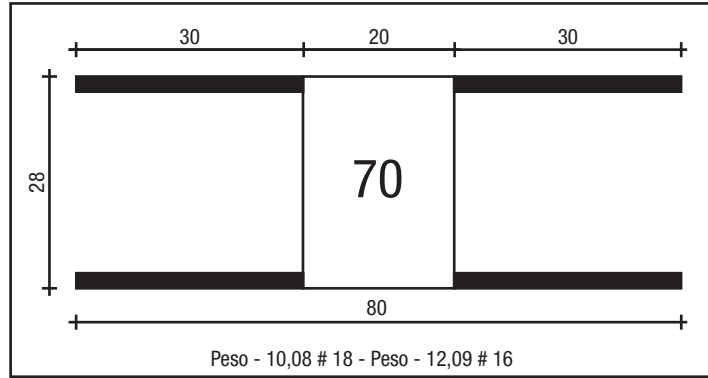
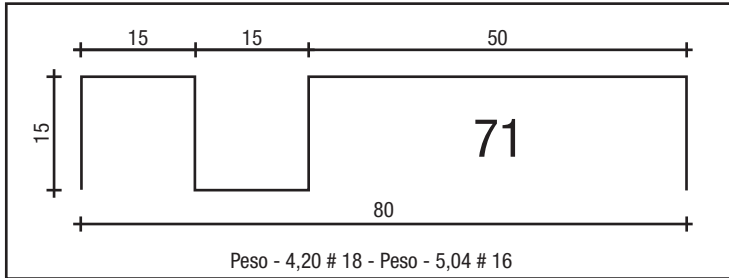
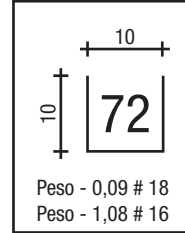
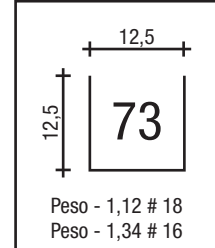
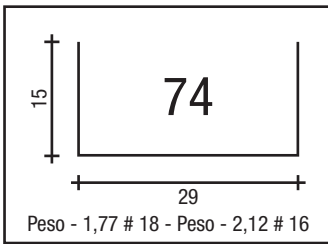
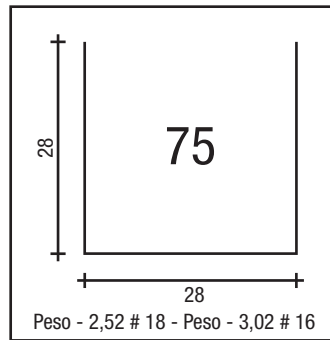
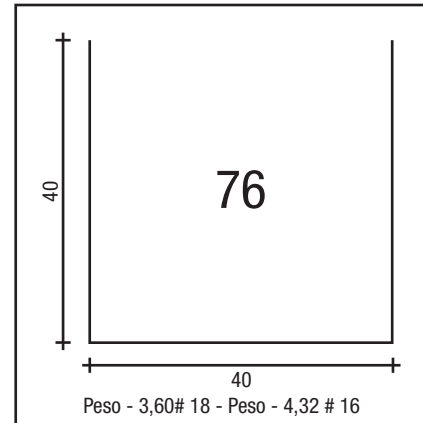
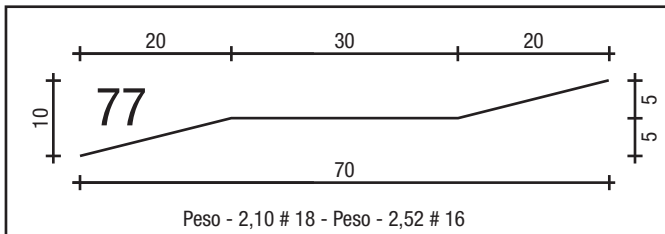
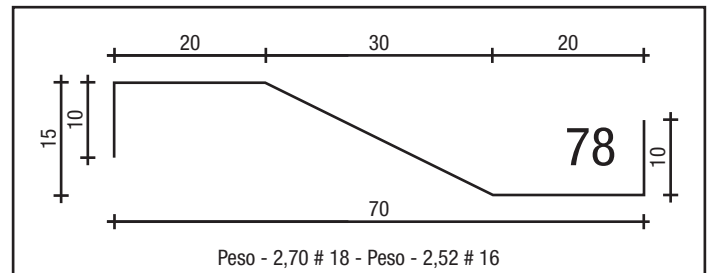
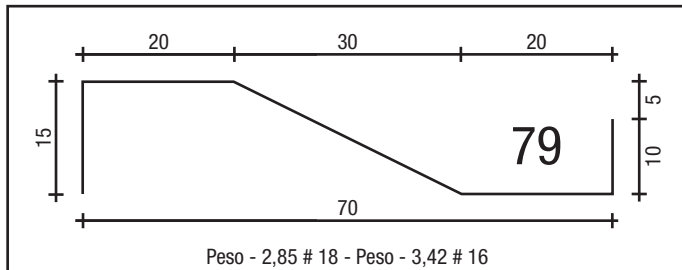
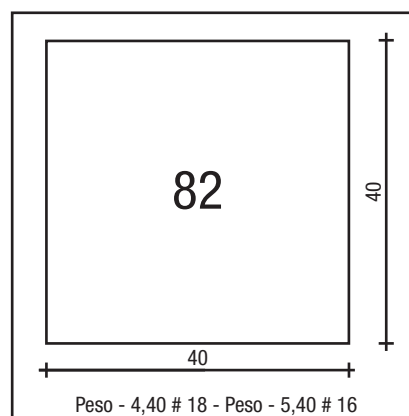
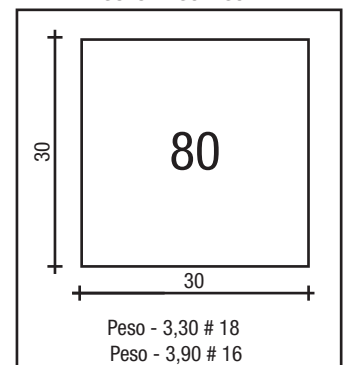
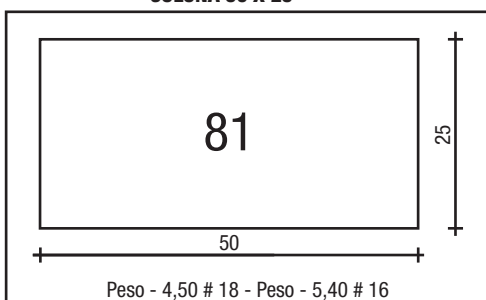
TRILHO M 45**TRILHO CENTRAL****TRILHO M 80****BAGUETE 3/8****BAGUETE 1/2****TRILHO U 15 X 29****TRILHO U 28 X 28****TRILHO U 40 X 40****PALHETA VENTILADA****PALHETA FECHADA 10 X 10****PALHETA FECHADA 10 X 15****COLUNA 40 X 40****COLUNA 30 X 30****COLUNA 50 X 25**

COLUNA 50 X 50

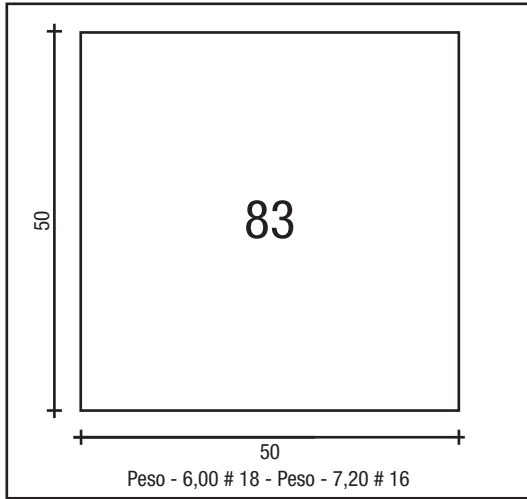

COLUNA 60 X 40

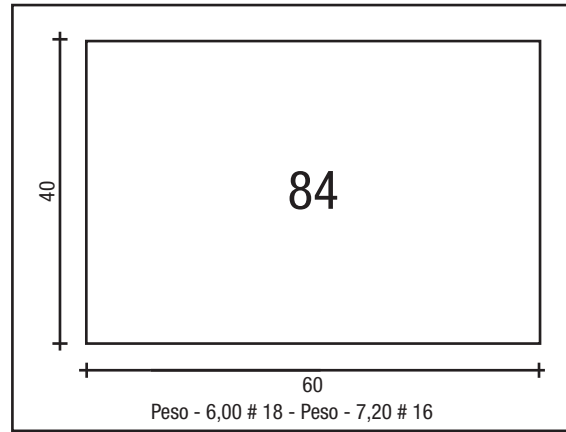

COLUNA 60 X 60

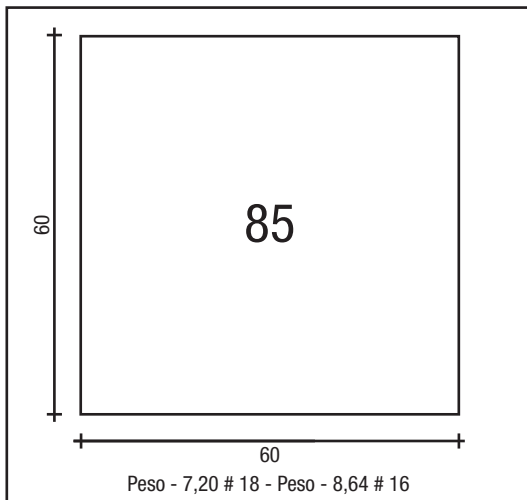

COLUNA 80 X 40

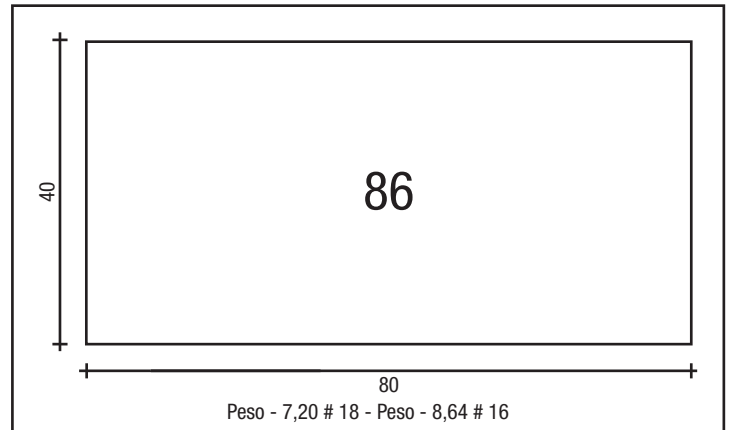

COLUNA 70 X 70

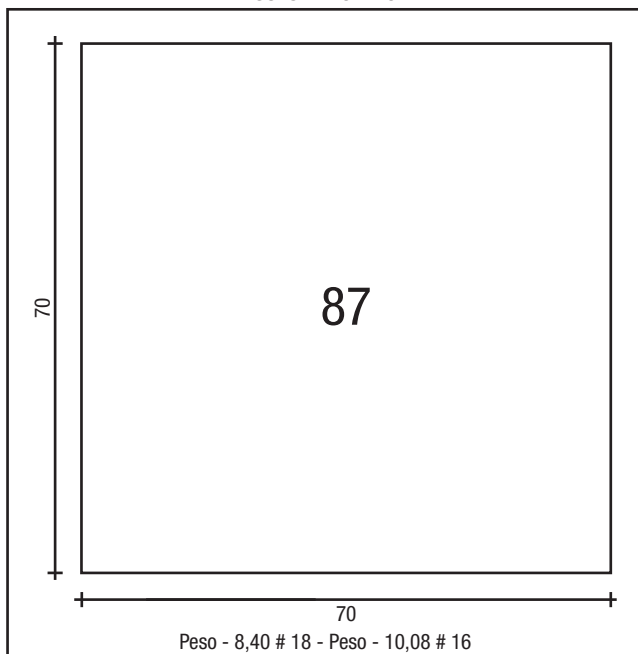

COLUNA 80 X 80

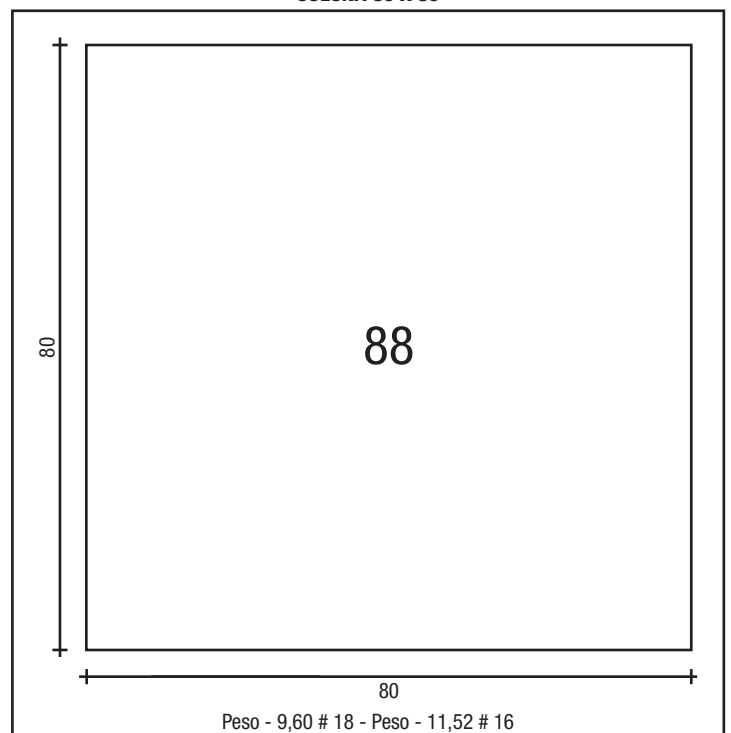

COLUNA 100 X 100

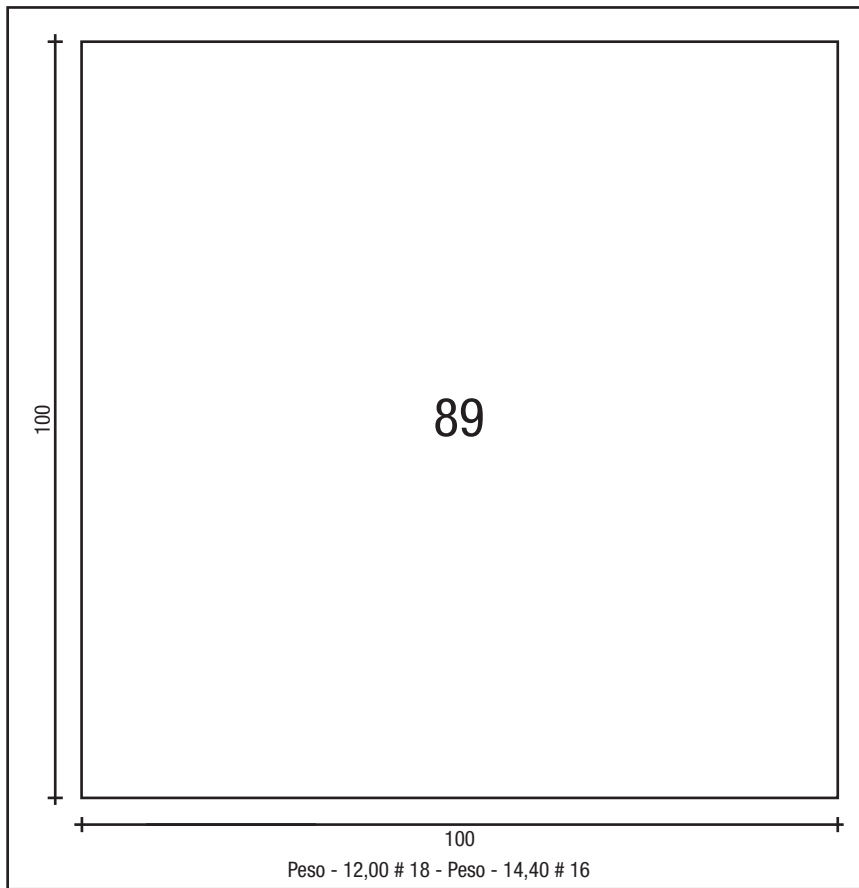

SOLEIRA

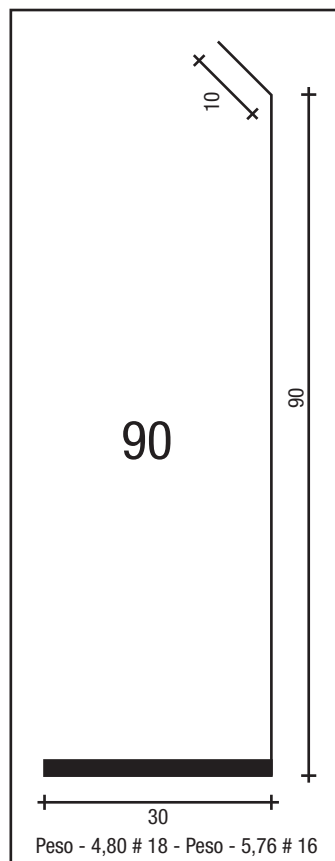

CONJUNTO PARA PORTÃO BASCULANTE / ELETRÔNICO

PESO TOTAL 99 kg # 16

TAMPA DA COLUNA LATERAL

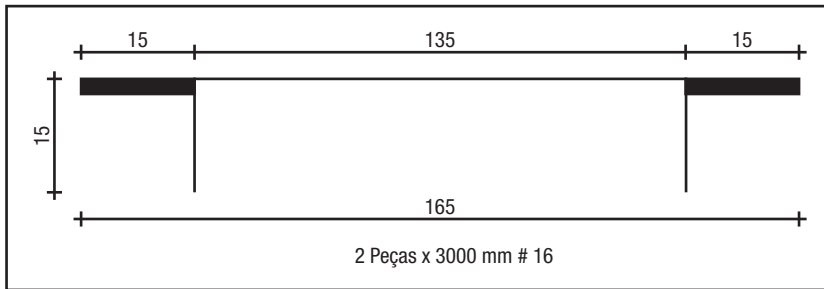

91

COLUNA LATERAL

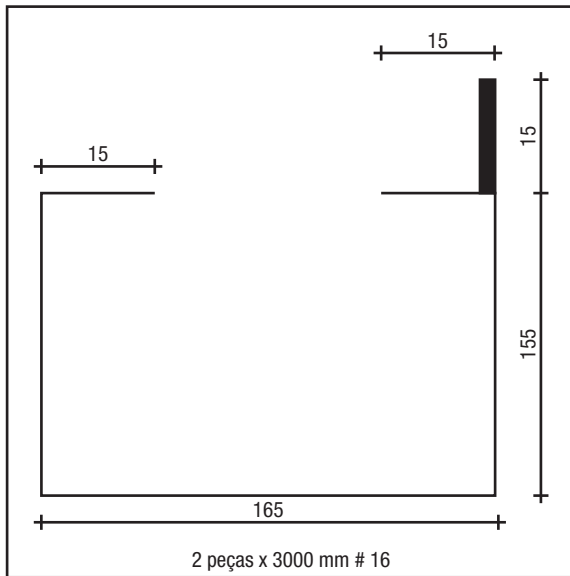

TRILHO

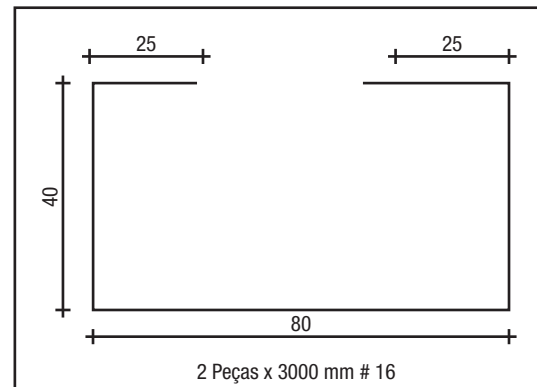

CAIXA DE PESO

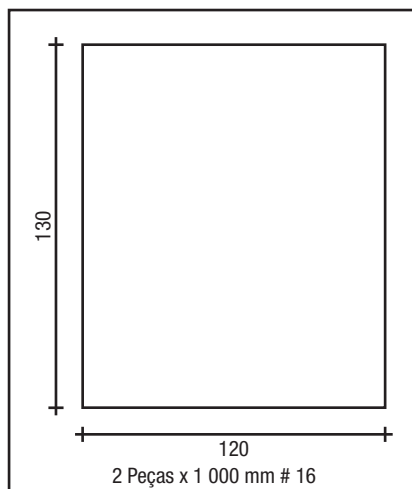

TRAVESSÃO

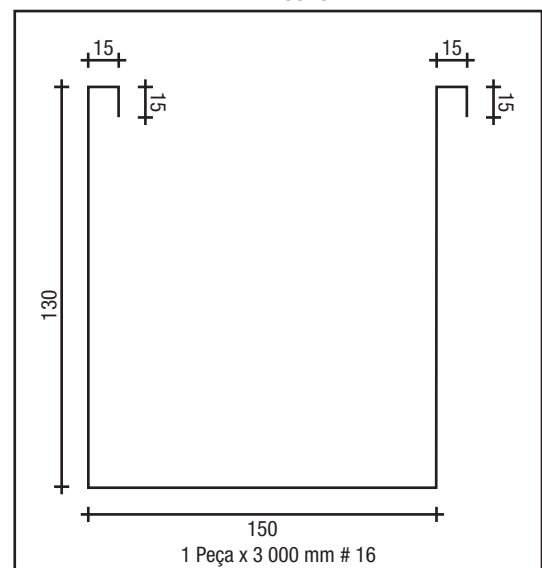

CONJUNTO PARA PORTÃO BASCULANTE / ELETRÔNICO

PESO TOTAL 88 kg # 18 - 108 # 16

TAMPA DA COLUNA LATERAL

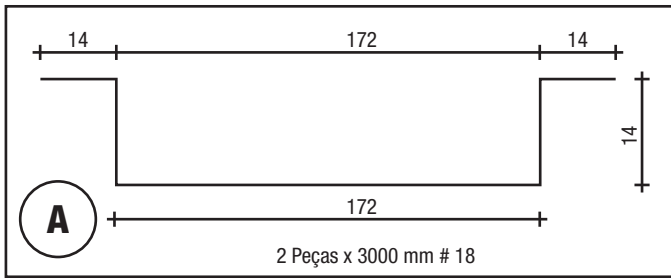

92

TRAVESSÃO

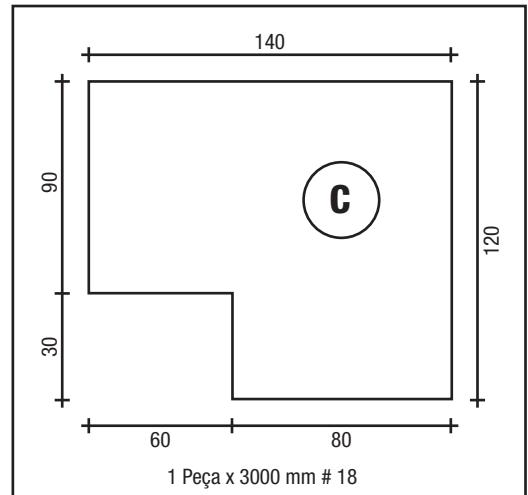

COLUNA LATERAL

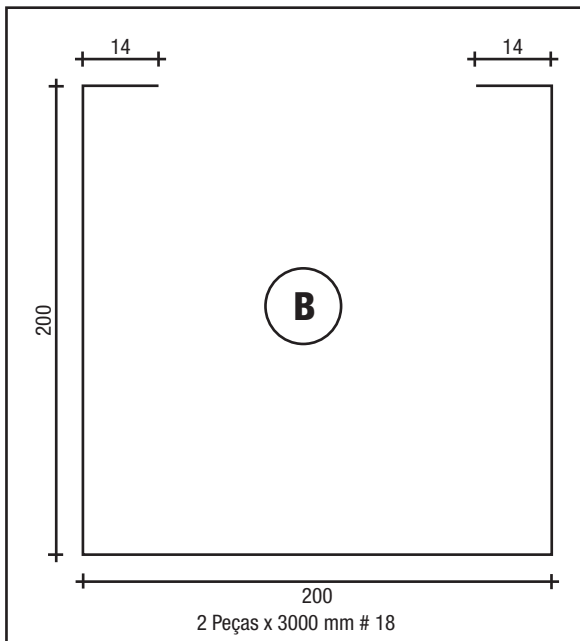

TRILHO

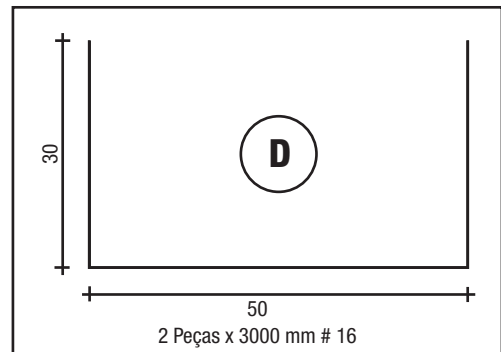

CAIXA DE PESO

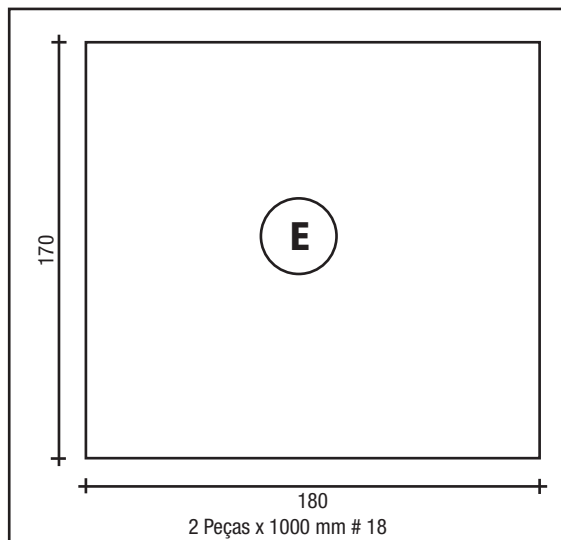

CONJUNTO PARA PORTÃO BASCULANTE / ELETRÔNICO

PESO TOTAL 70 kg # 18 - 86 kg # 16

TAMPA DA COLUNA LATERAL

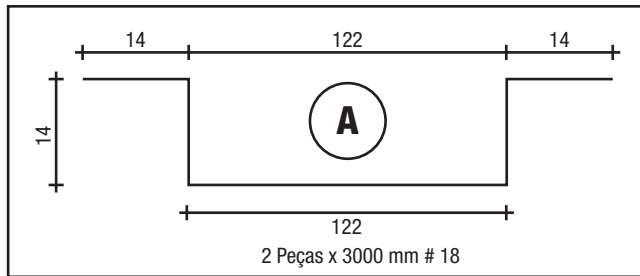

COLUNA LATERAL

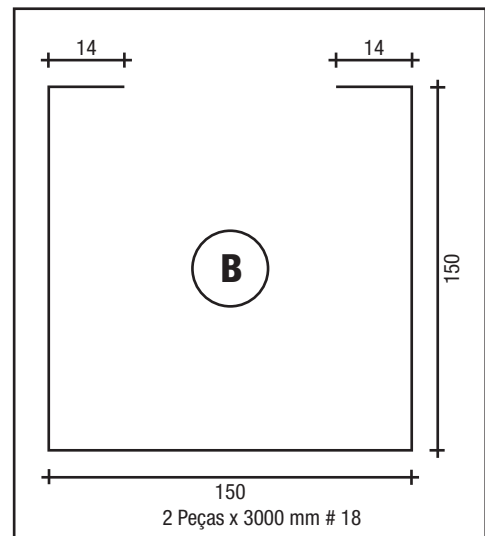

TRAVESSÃO

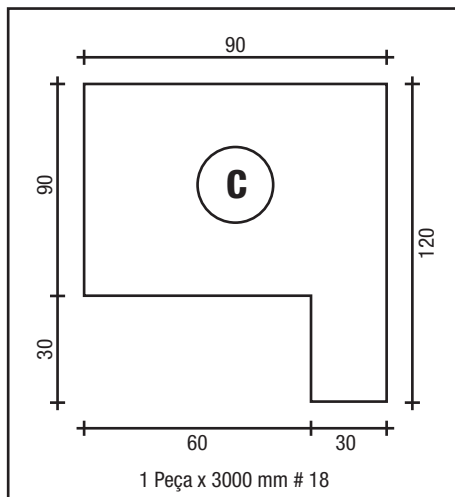

93

CAIXA DE PESO

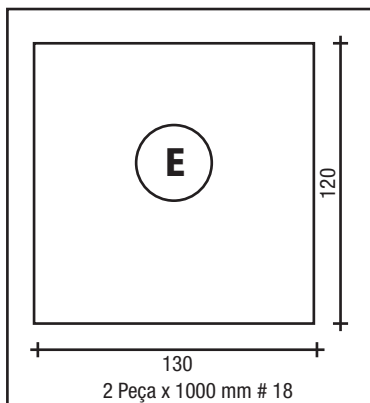

TRILHO

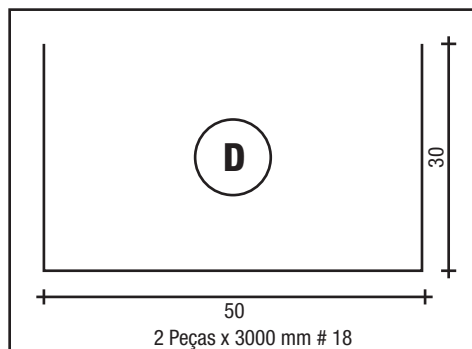

CAIXA ABERTA DE 150 # 16

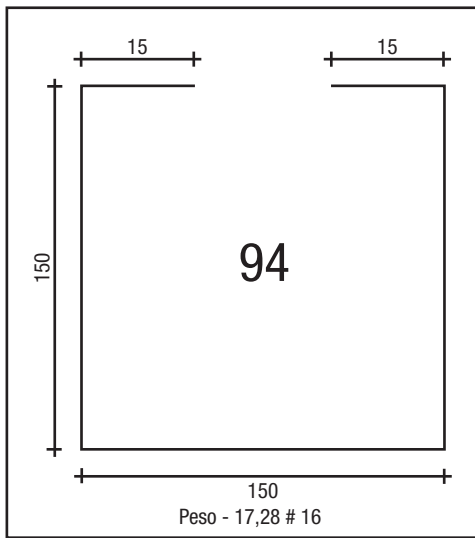

TAMPA DE CAIXA DE 150 # 16

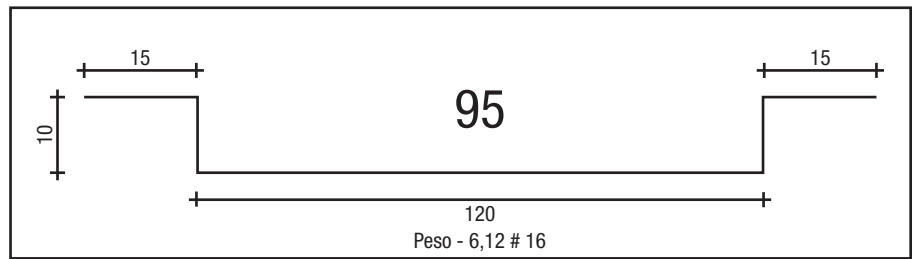

COLUNA 150 X 150 # 16

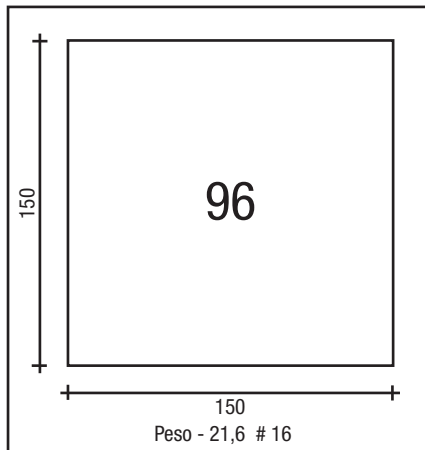

TRILHO PORTÃO ELEVAÇÃO 50 X 50 # 14

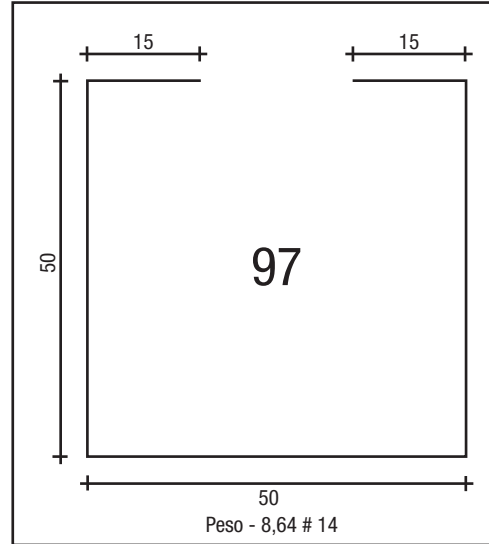

CAIXA ABERTA DE 180 # 16

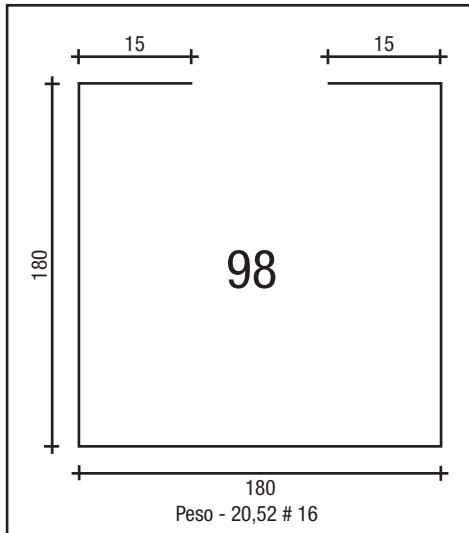

TAMPA DE CAIXA DE 180 # 16

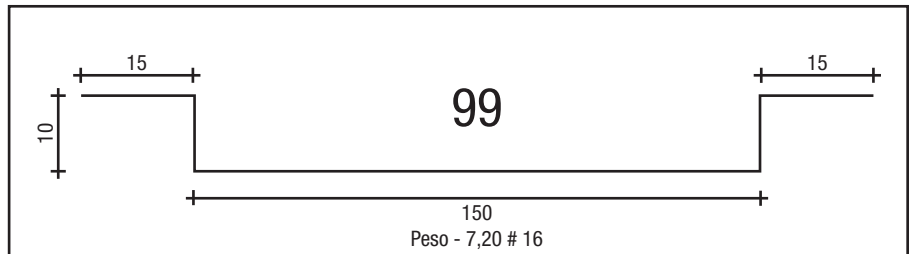

COLUNA 180 X 180 # 16

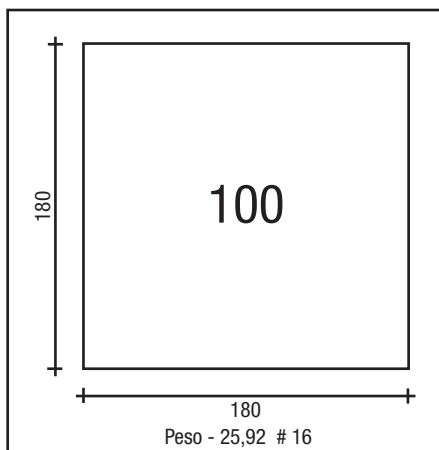

TRILHO PORTÃO ELEVAÇÃO 65 X 50 # 14

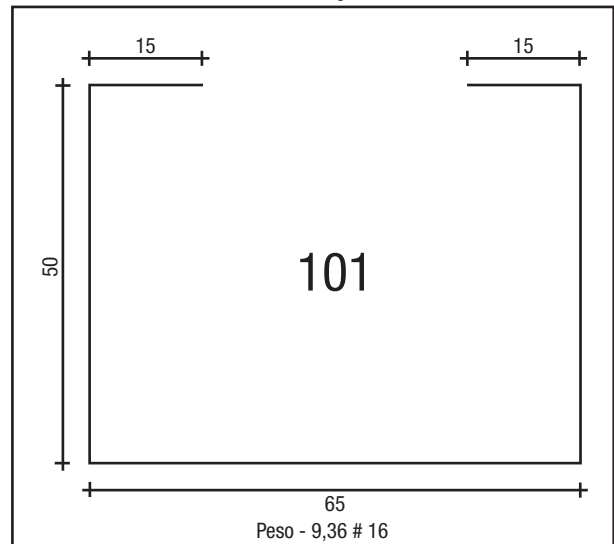

CAIXA ABERTA DE 200 # 16

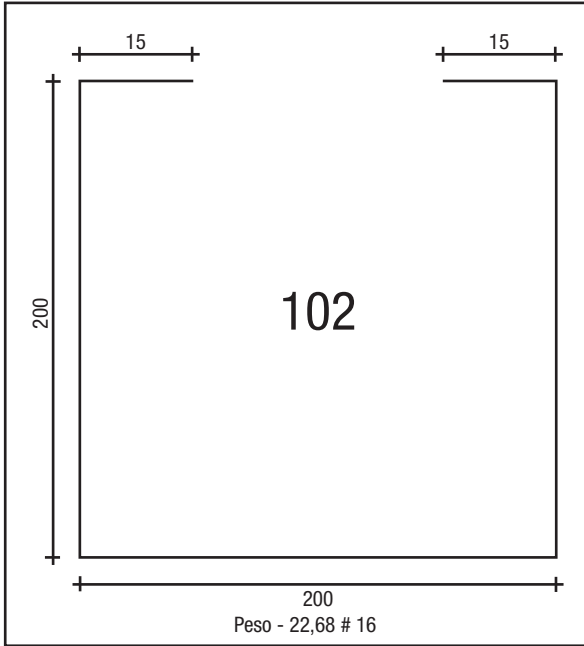

TAMPA DE CAIXA DE 200 # 16

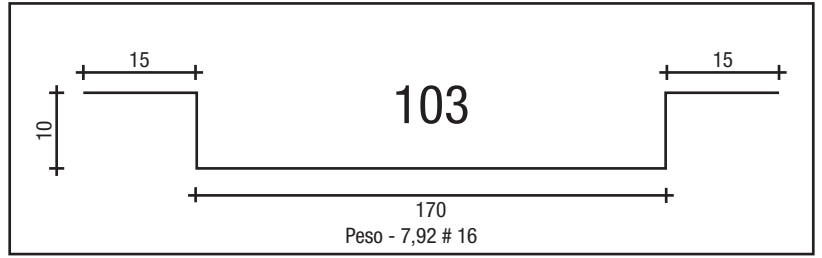

COLUNA 120 X 120 # 16

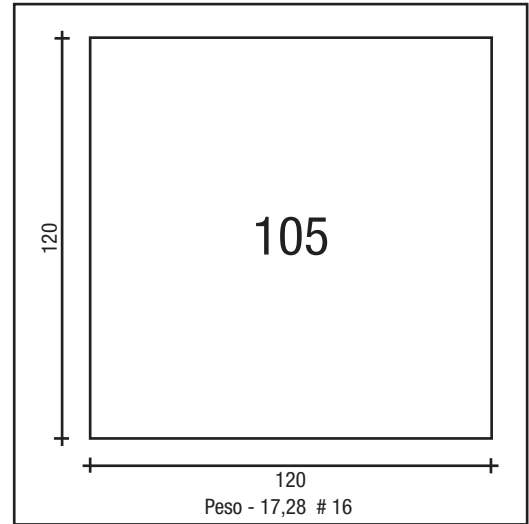

COLUNA 200 X 200 # 16

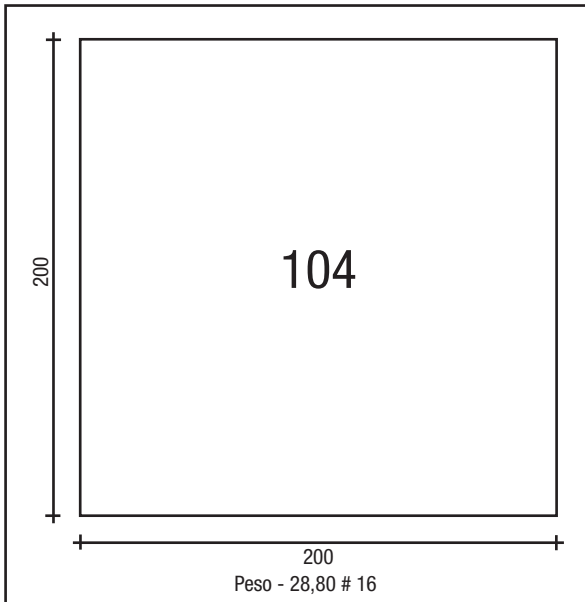

COLUNA 150 X 40 # 16

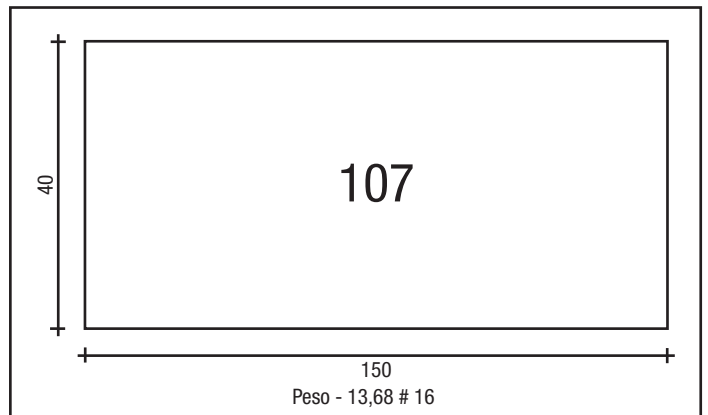

COLUNA 130 X 130 # 16

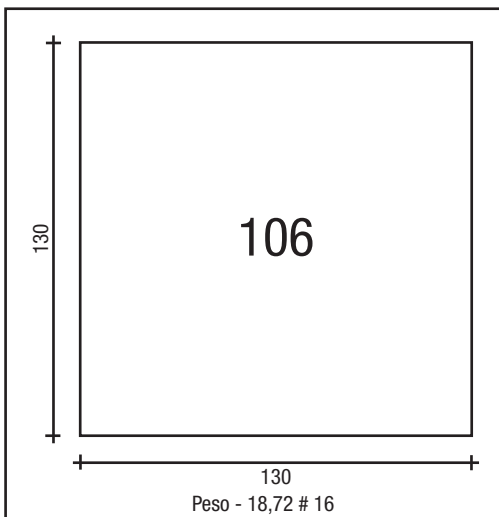

COLUNA 150 X 100 # 16

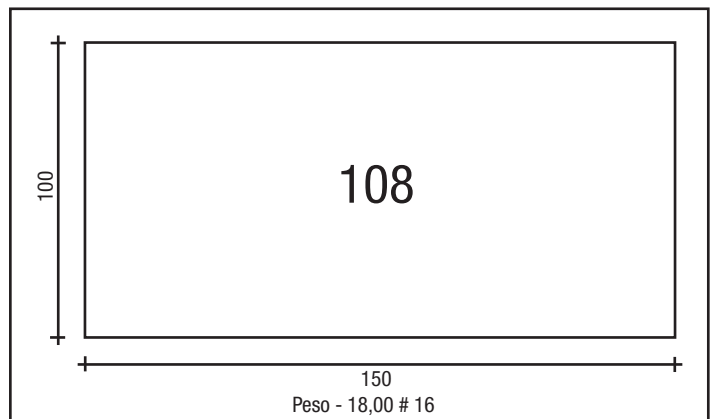

LATERAL DE 60 # 16

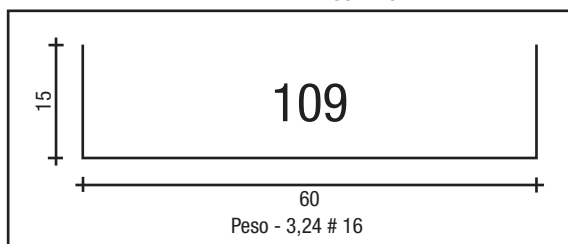

LATERAL DE 70 # 16

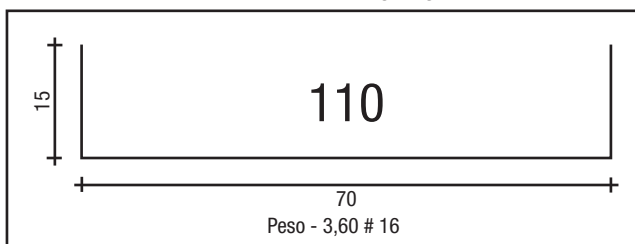

LATERAL DE 80 # 16

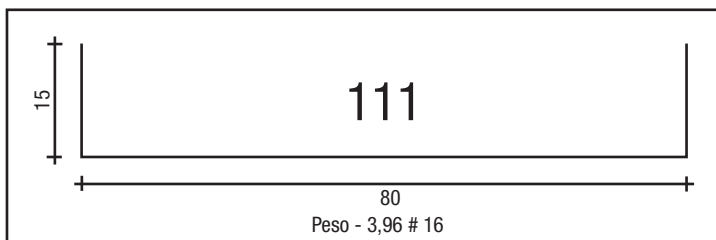

LATERAL DE 100 # 16

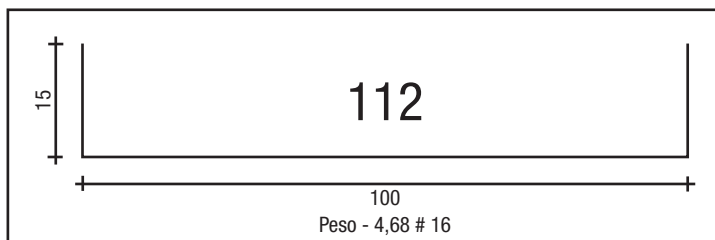

LATERAL DE 120 # 16

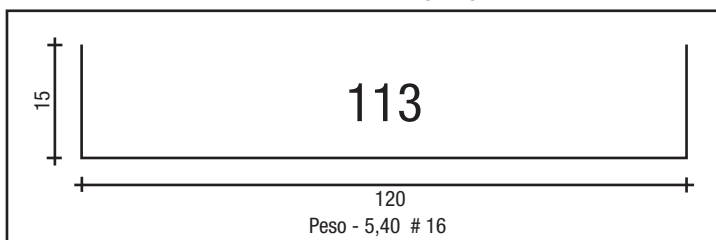

LATERAL DE 130 # 16

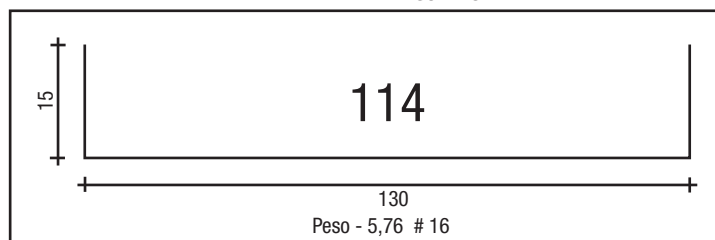

LATERAL DE 140 # 16

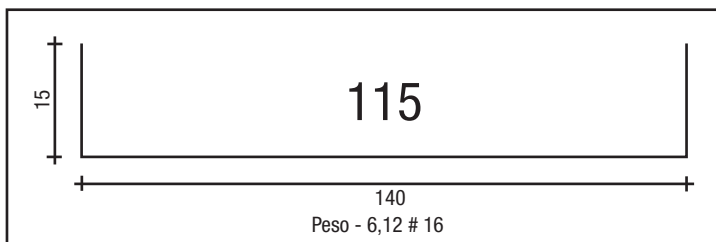

LATERAL DE 150 # 16

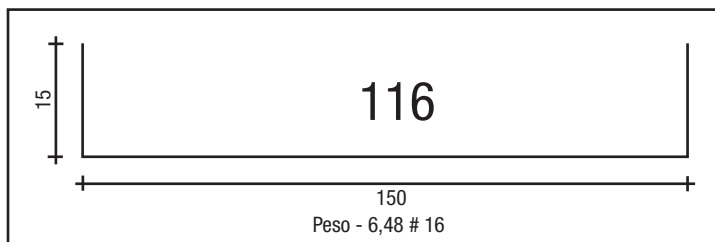

LATERAL DE 160 # 16

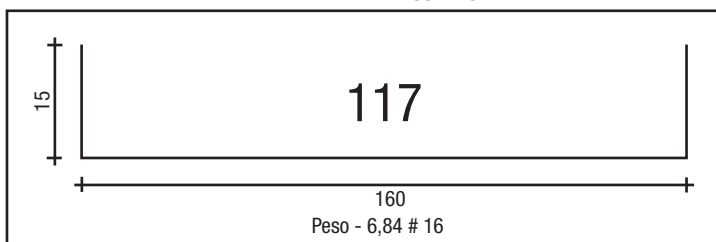

LATERAL DE 200 # 16

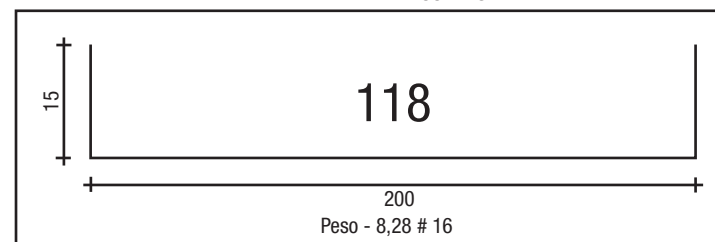

TRILHO G 50 X 50 X 35 # 14

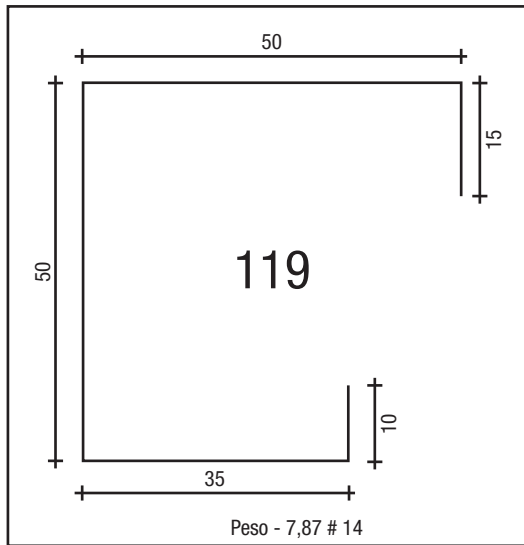

TAMPA G # 16

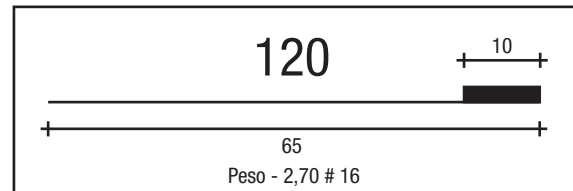

TEE 20 X 25 X # 16

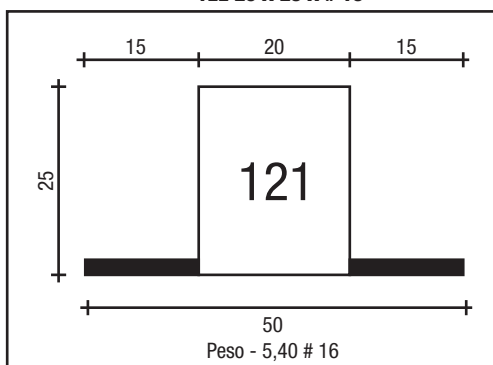

TRAVA 22 X 22 X # 16

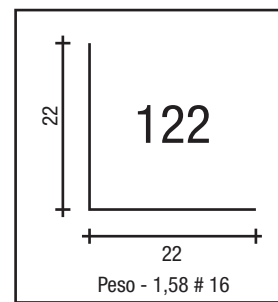

Z MAX 25 X 15 X 20 X 15 # 16

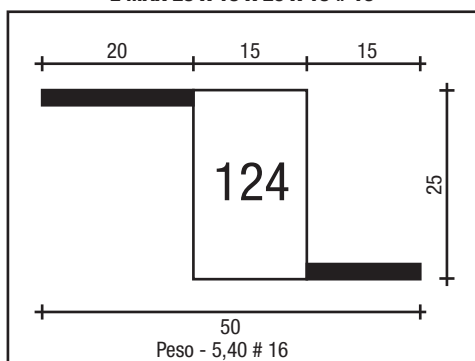

Z MAX 30 X 15 X 20 X 15 # 16

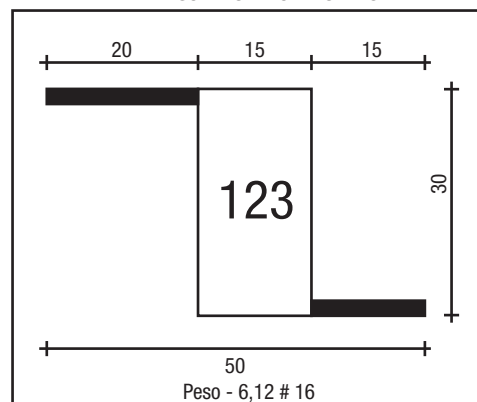

CAD. TRAVA P/ BAIXO 30 X 25 # 16

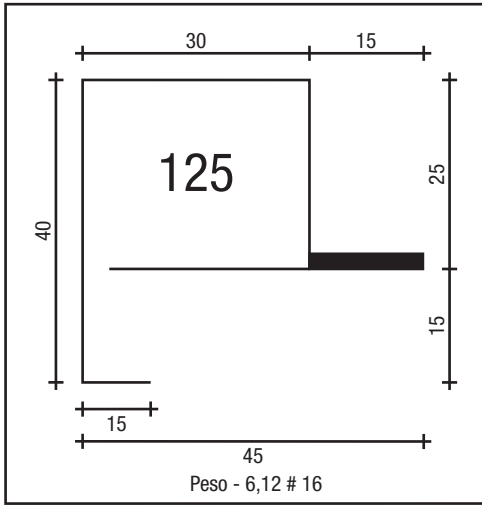

CAD. TRAVA P/ CIMA 30 X 25 # 16

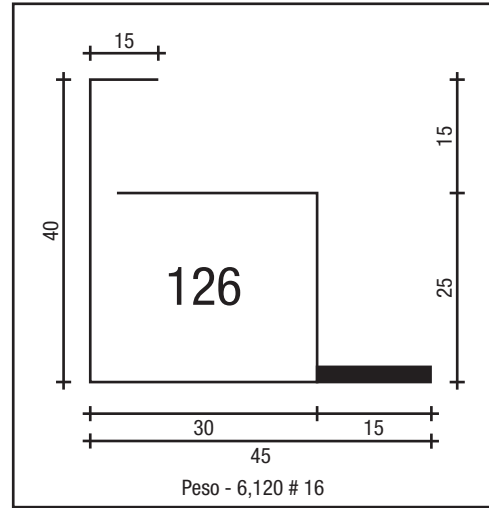

CAD. TRAVA P/ BAIXO 50 X 30 # 16

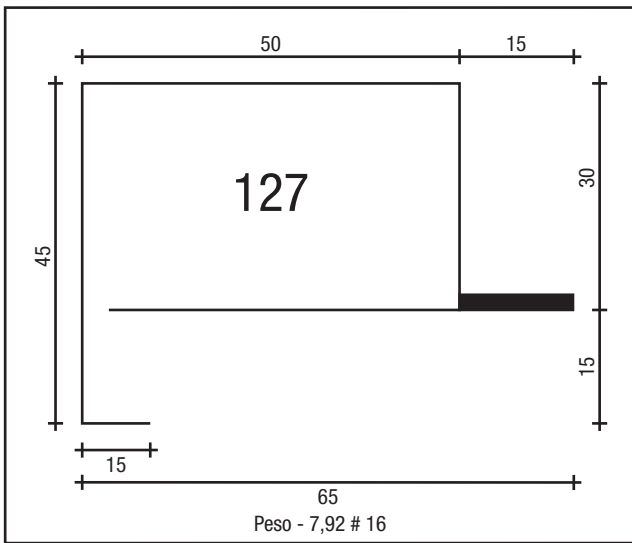

CAD. TRAVA P/ CIMA 50 X 30 # 16

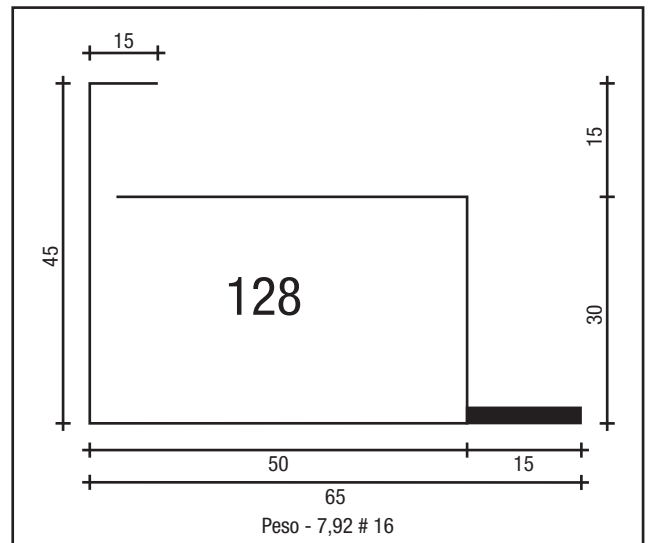

CAD. 35 X 25 # 16

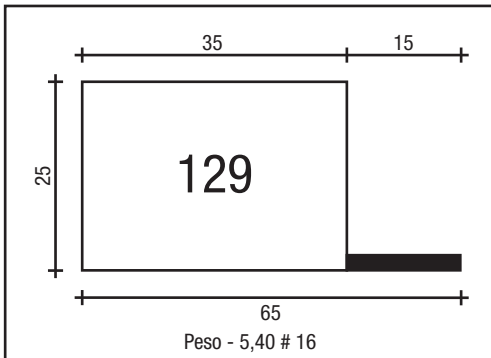

CAD. ABERTA 30 X 25 # 16

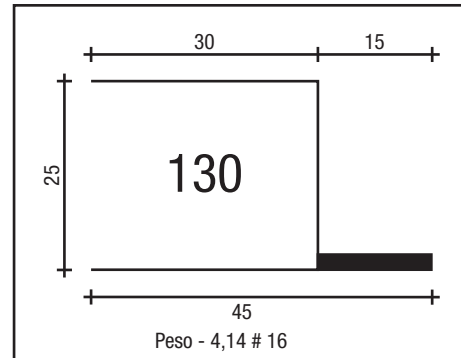

CAD. ABERTA 30 X 30 # 16

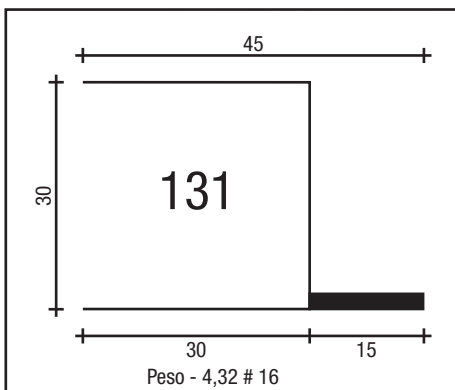

CAD. ABERTA 50 X 25 # 16

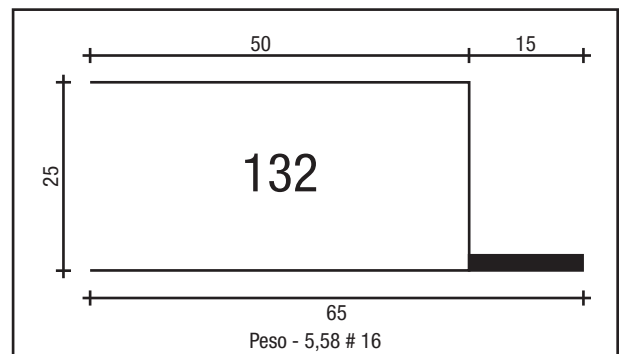

BATENTE 120 X 30 # 16

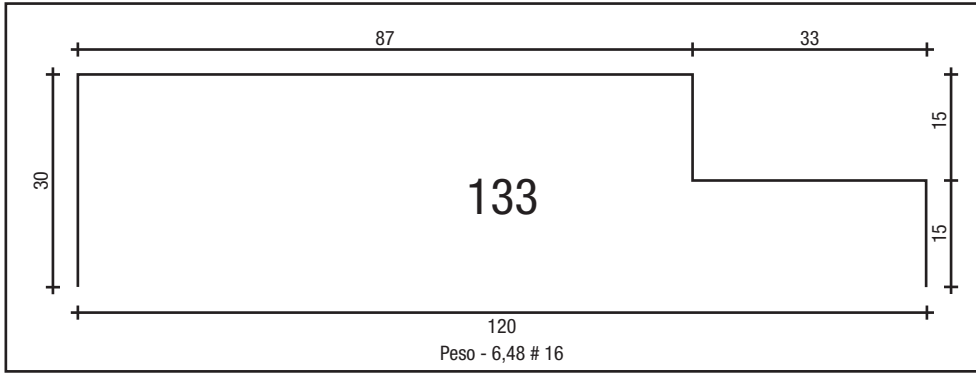

**BATENTE FECH. P/
PORTA COR. 25 # 16**

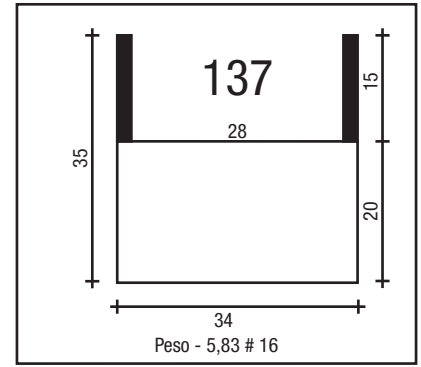

BATENTE 120 X 25 # 16

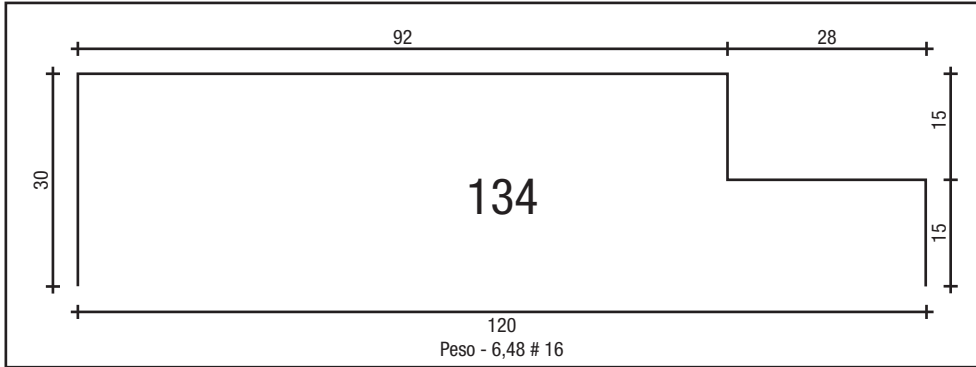

**BATENTE FECH. P/
PORTA COR. 30 # 16**

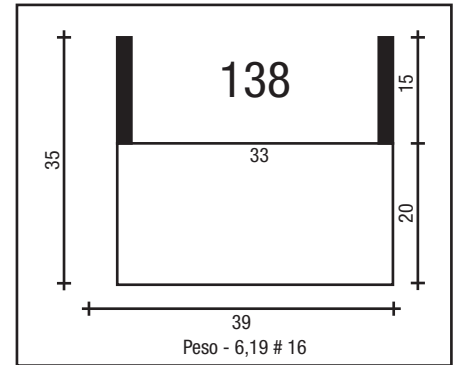

BATENTE 140 X 30 # 16

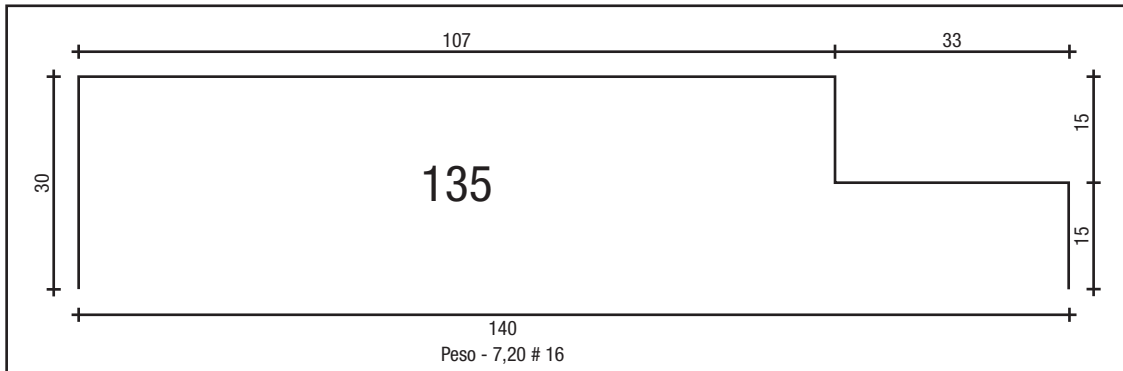

BATENTE 140 X 25 # 16

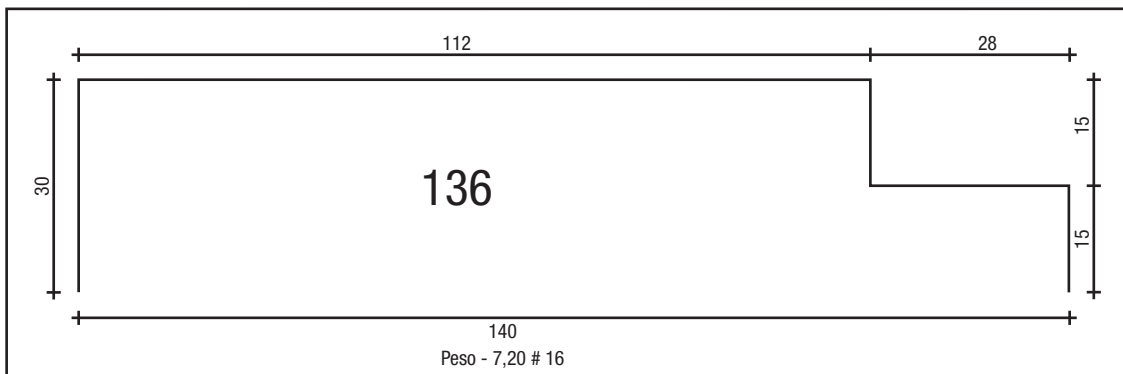

BATENTE 48 # 16

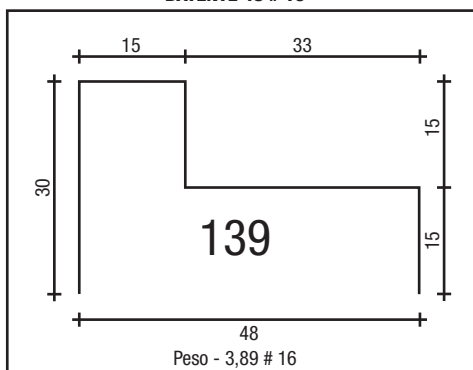

BATENTE 43 # 16

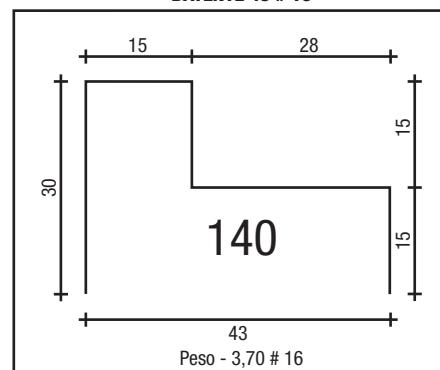

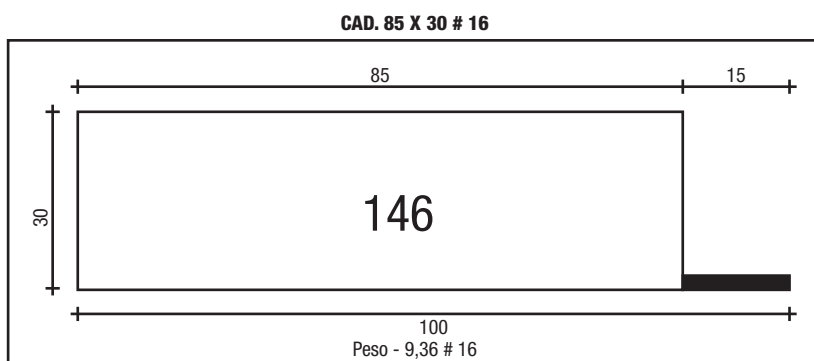
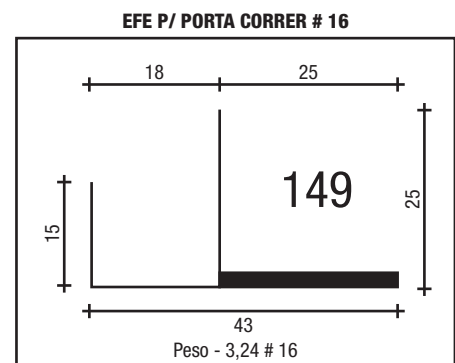
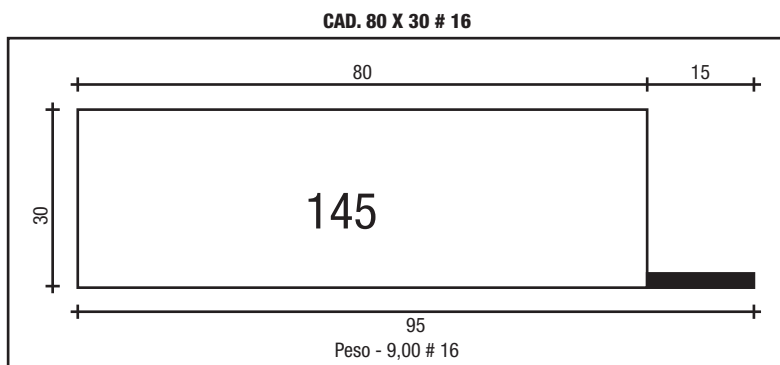
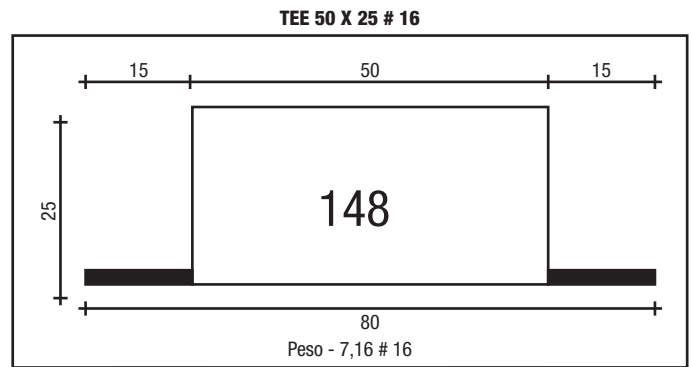
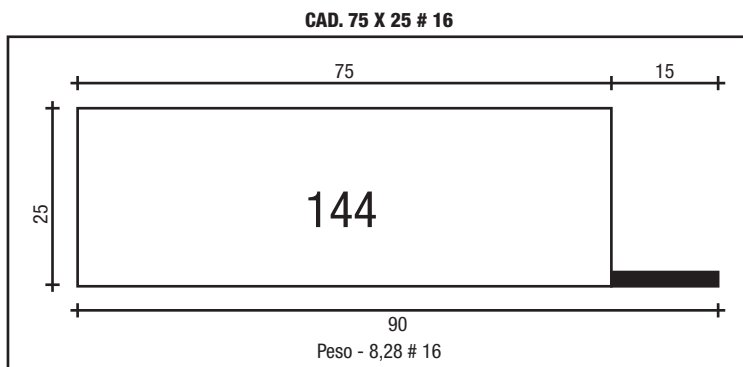
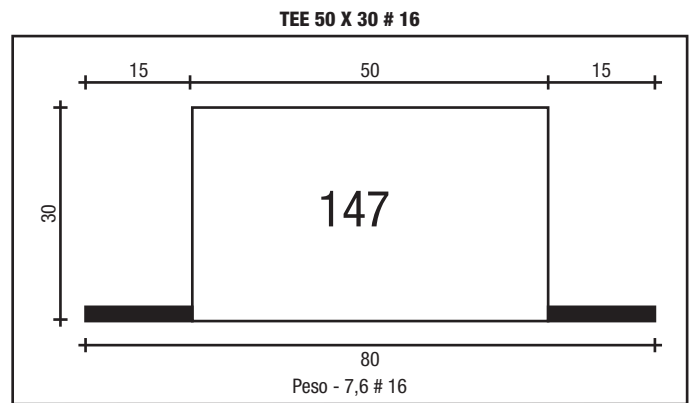
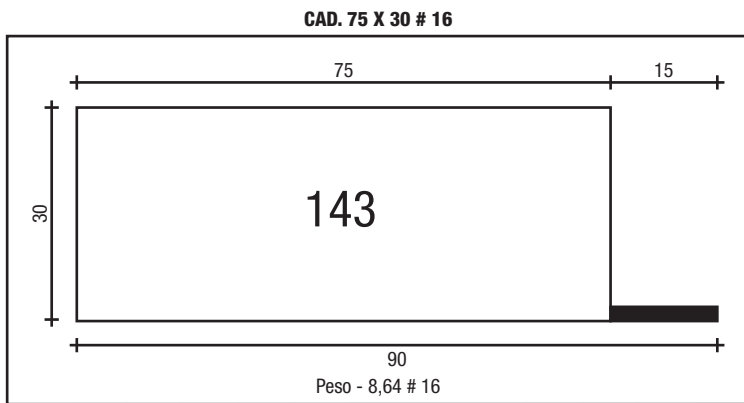
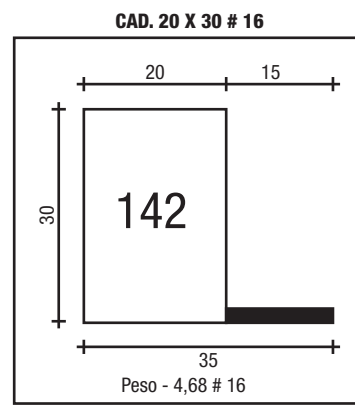
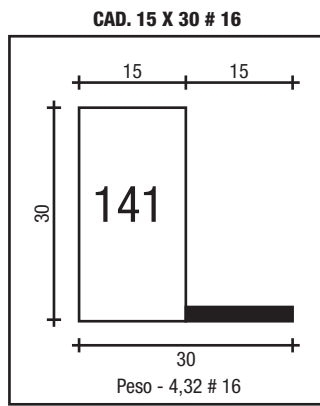

PALHETA VENTILADA 6 X 6 # 18

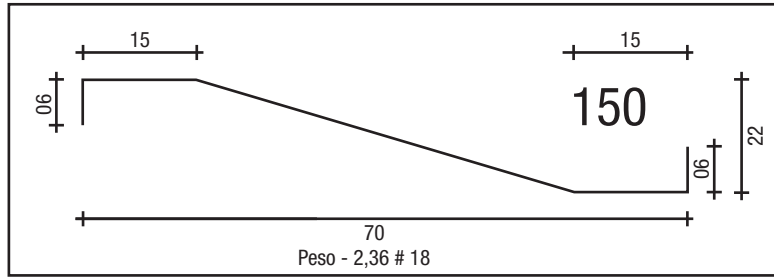

PALHETA VENTILADA 6 X 20 # 18

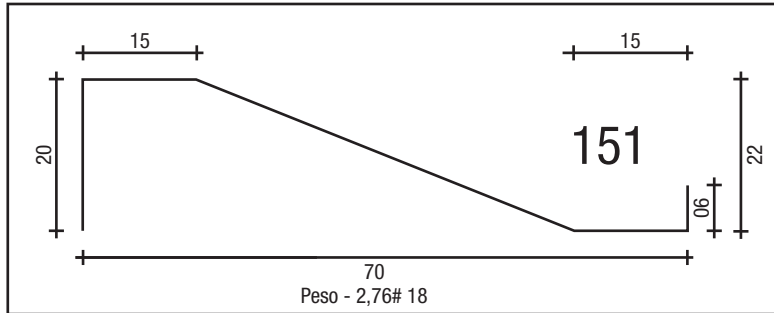

ACABAMENTO 100 # 18 e # 20

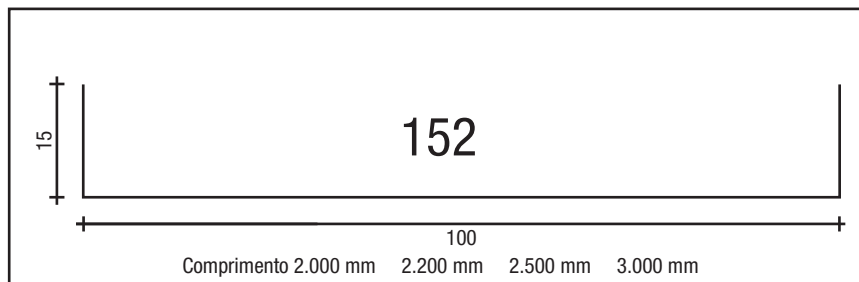

LAMBRIL # 18 e # 20

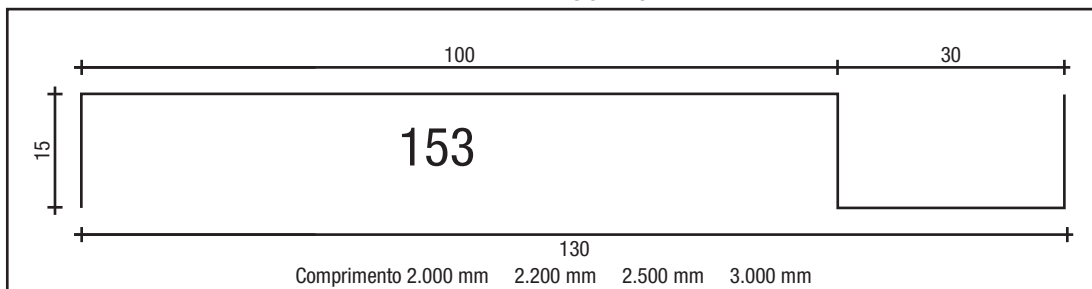

PAINEL # 18 e # 20

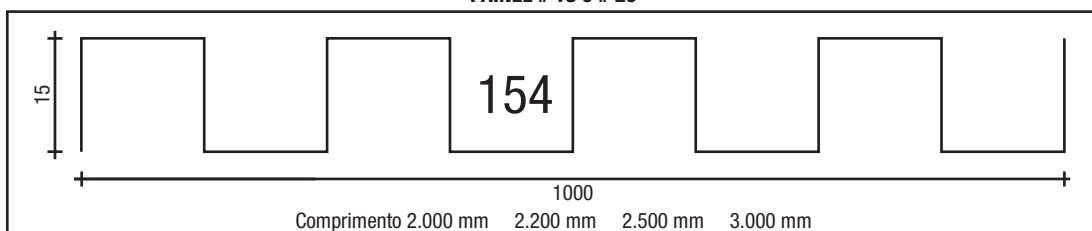

CAIXA ABERTA DE 120 # 16

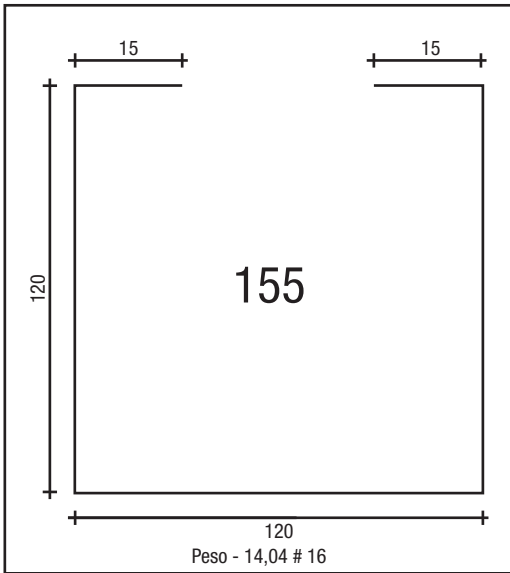

TAMPA DA CAIXA DE 120 # 16

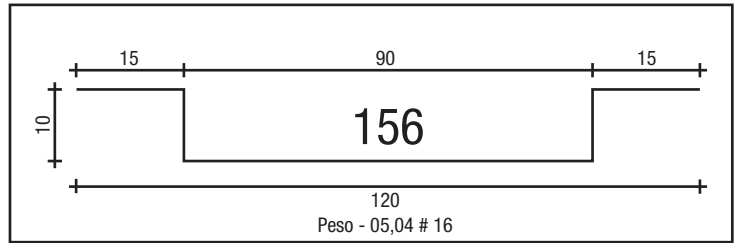

TRILHO VITRAUX 120 # 16

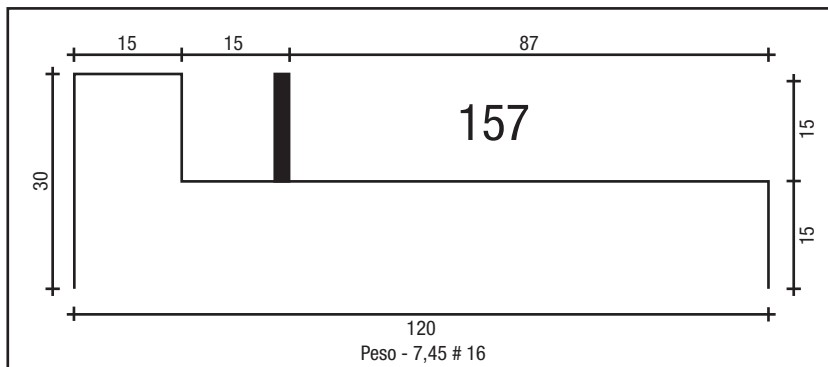

TRILHO VITRAUX 150 # 16

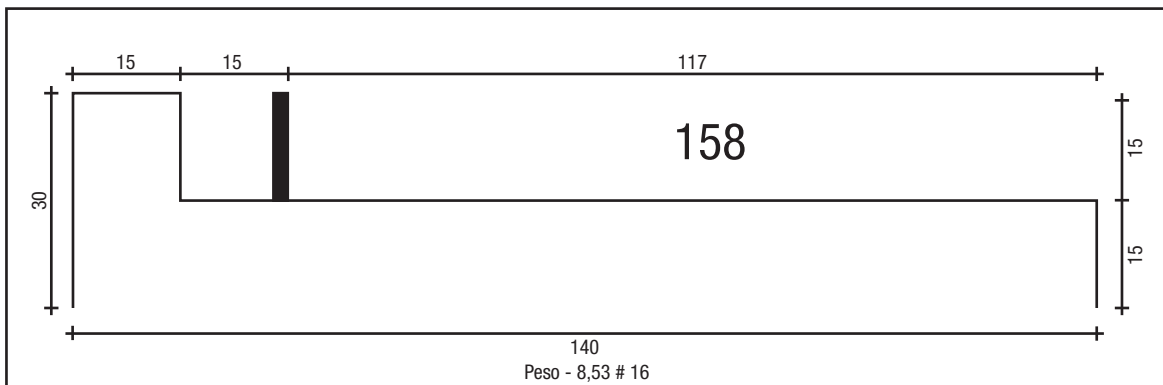

BATENTE 140 # 16

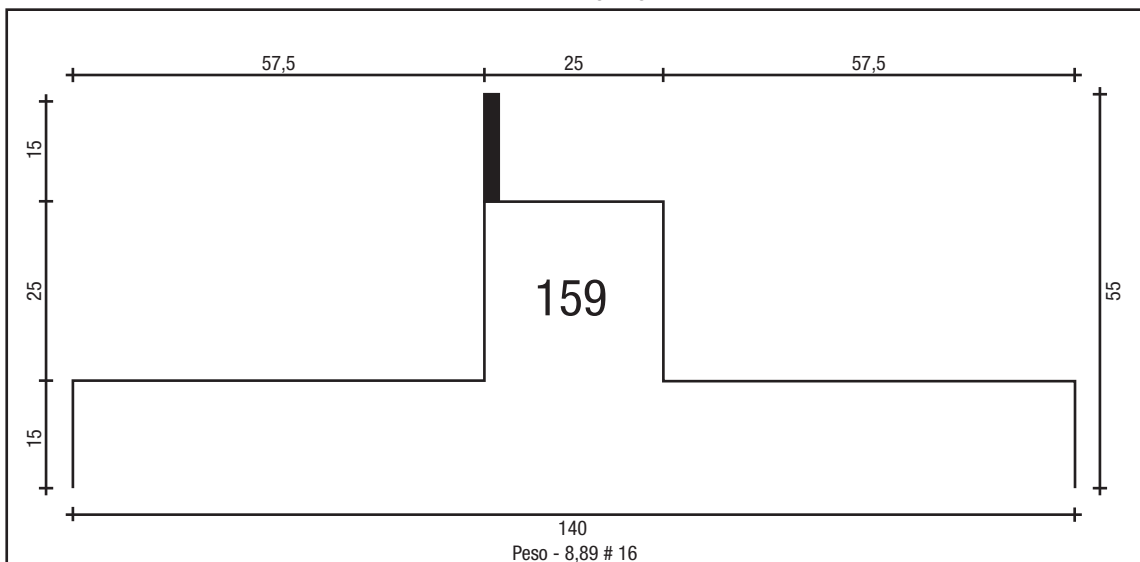

BATENTE DUPLO DE 140 # 16

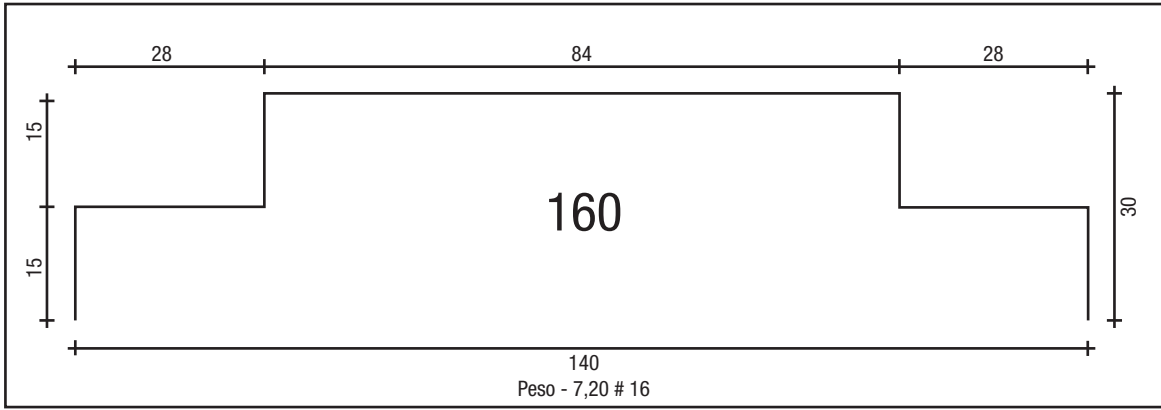

TEE 45 X 25 # 16

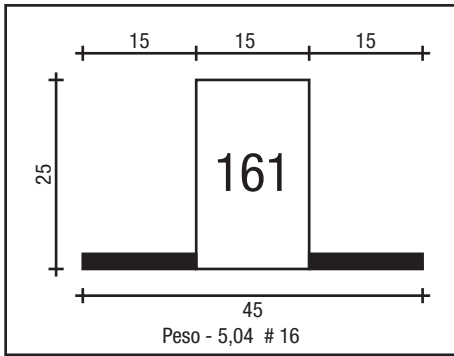

TEE 50 X 30 # 16

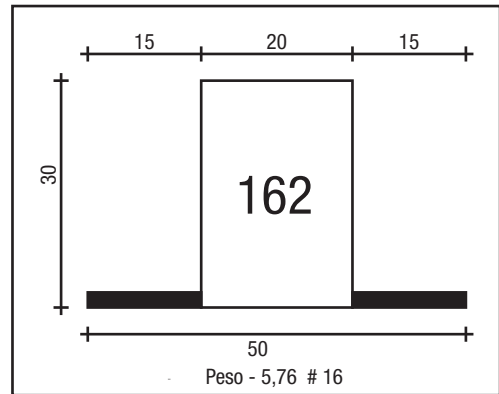

CONDUTOR CORTE 28 # 28 GALV.



CONDUTOR CORTE 33 # 28 GALV.



CALHA MOLDURA # 26 GALV.

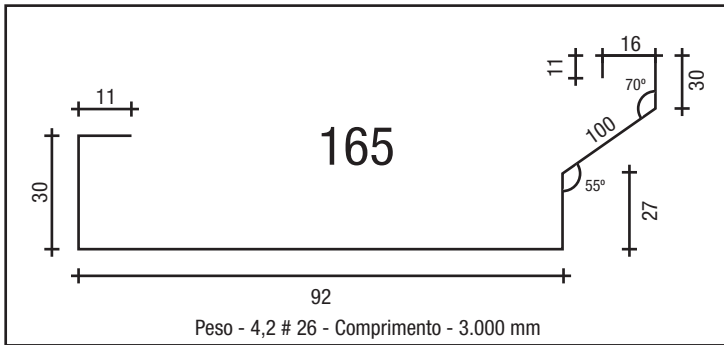

ÁGUA FURTADA # 26 GALV.

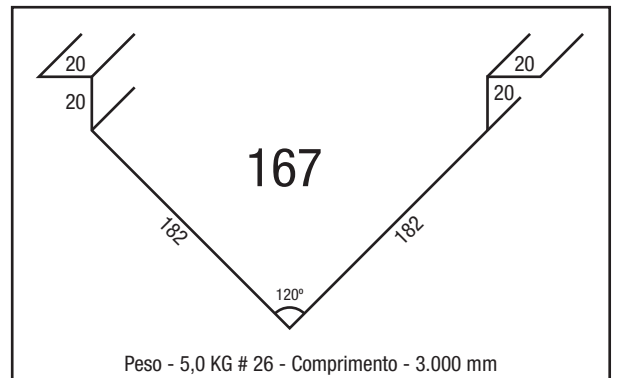

CALHA L # 26 GALV.

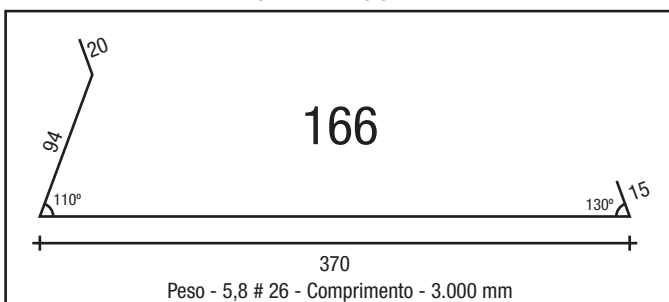

CONJUNTO PARA PORTÃO BASCULANTE 150 / ELETRÔNICO

PESO TOTAL 100,9 kg # 16 - Com Trilho # 14

PESO TOTAL 84,4 KG # 18 - Com Trilho # 16

TAMPA DA COLUNA LATERAL

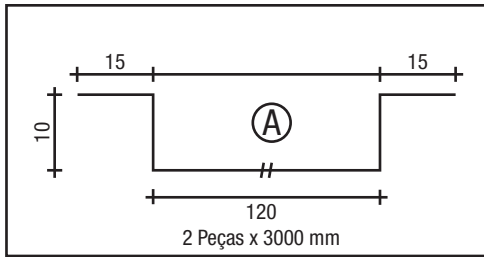

TRILHO

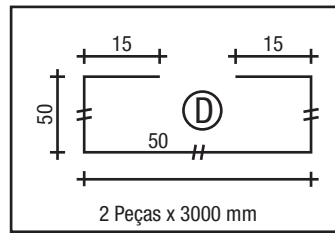

168

COLUNA LATERAL

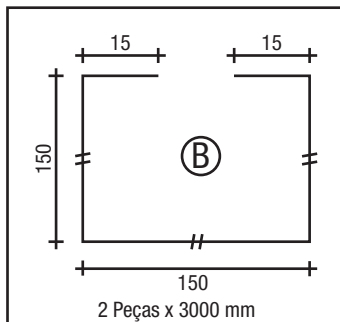

TRAVESSÃO

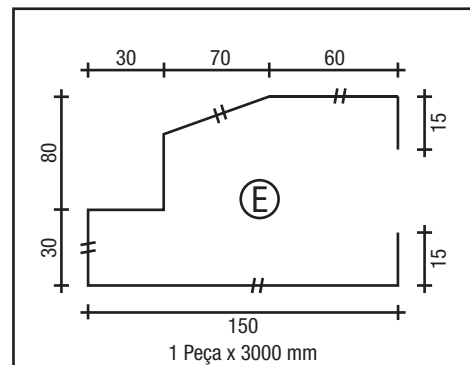

CAIXA DE PESO

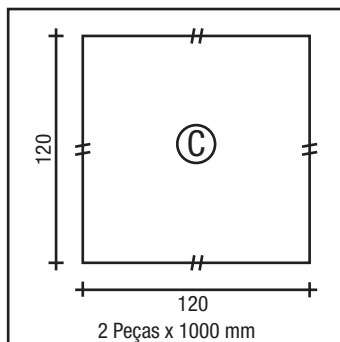

TAMPA DO TRAVESSÃO

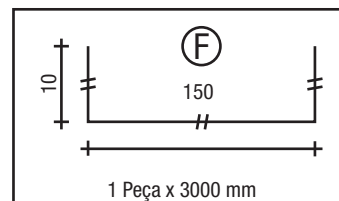

CONJUNTO PARA PORTÃO BASCULANTE 170 / ELETRÔNICO

PESO TOTAL 112,9 kg # 16 - Com Trilho # 14

PESO TOTAL 93 KG # 18 - Com Trilho # 16

TAMPA COLUNA LATERAL

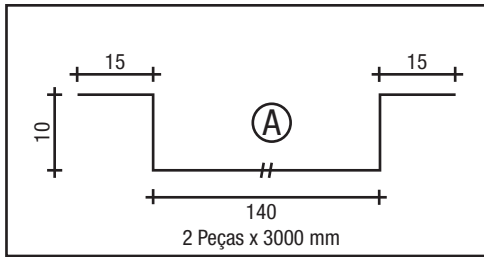

TRILHO

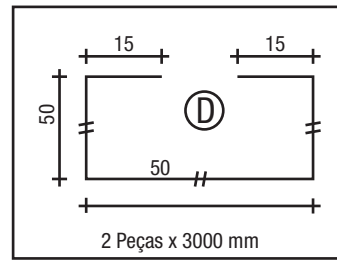

169

COLUNA LATERAL

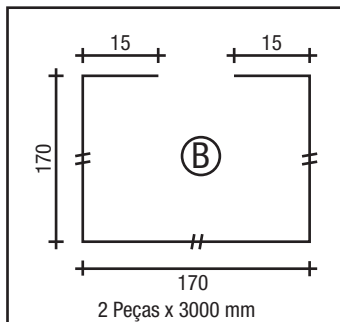

TRAVESSÃO

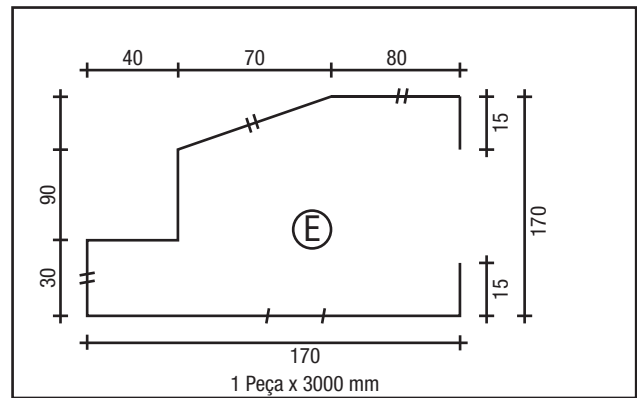

CAIXA DE PESO

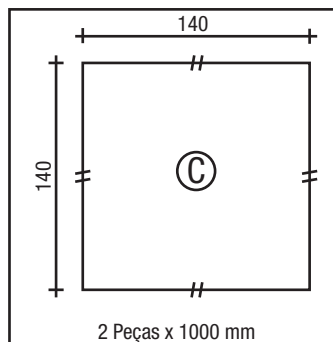

TAMPA DO TRAVESSÃO

